

螺絲救星 **SCREW SAVER**

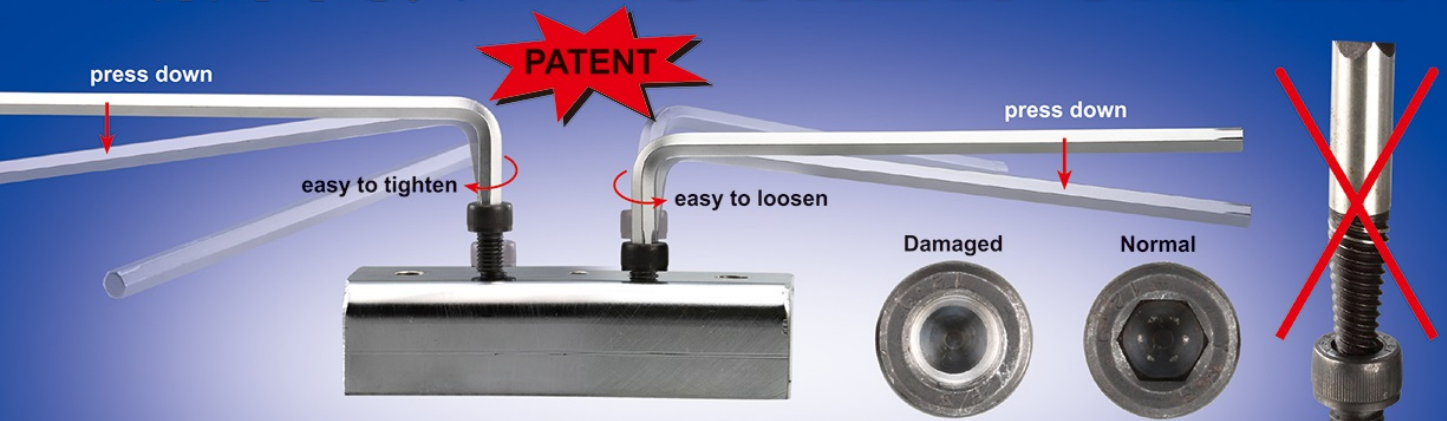

► Fit the damaged screw in seconds. It could replace the traditional screw extractor.

► When screw is in good condition, unique hex extractor design will not damage screw forever.

Magnet

Long shaft ball head with detent ball, specially designed for user to reach into deep or a narrow area.



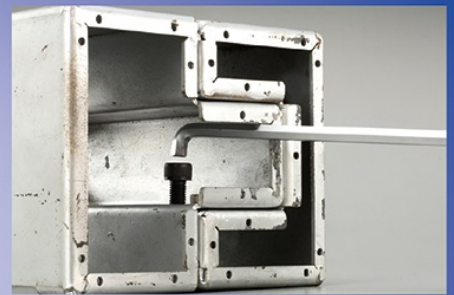

































































Easy to choose any size.

























































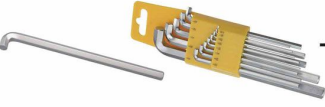

























































Stubby hex key design allows user to use in difficult tight space.

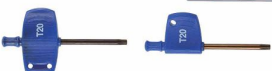

CONTENT

 	3	 	4
 	5	 	6
 	7	 	8
 	9	 	10
 	11	 	12
 	13	 	14
 	15	 	16
 	17	 	18
 	19	 	20
 	21	 	22
 	23	 	24
 	25	 	26
 	27	 	28
 	29	 	30
 	31	 	32
 	33	 	34
 	35	 	36

CONTENT

  37	  38
   39	   40
  41	  42
  43	  44
    45	  46
     47	    48
     49	      50
  51	  52
  53	  54
   55	    56
   57	    58
   59	    60
   61	    62
     63	     64
     65	     66
   67	    68
   69	   70



HEX KEY

SHORT ARM SERIES

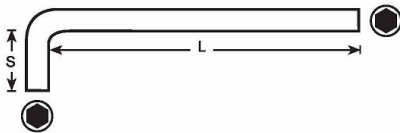
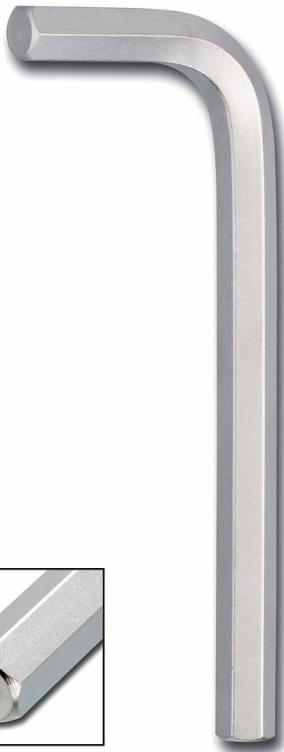

ITEM NO.	SIZE (mm)	L (mm)	S (mm)	⚖️ (g)
01-007	0.7	35	8	0.15
01-009	0.9	38	10	0.25
01-010	1.0	41	12	0.37
01-012	1.2	46	14	0.58
01-013	1.3	40	12	0.6
01-015	1.5	45	14	0.9
01-020	2.0	50	16	1.8
01-025	2.5	56	18	3.2
01-030	3.0	63	20	5.0
01-035	3.5	65	22	7.0
01-040	4.0	70	25	10.0
01-045	4.5	75	26	14.0
01-050	5.0	80	28	18.0
01-055	5.5	85	30	24.0
01-060	6.0	90	32	30.0
01-070	7.0	95	34	43.0
01-080	8.0	100	36	60.0
01-090	9.0	106	38	81.0
01-100	10.0	112	40	105.0
01-110	11.0	118	42	133.0
01-120	12.0	125	45	170.0
01-130	13.0	132	50	212.0
01-140	14.0	140	56	265.0
01-150	15.0	150	57	320.0
01-160	16.0	153	57	370.0
01-170	17.0	160	63	442.0
01-180	18.0	170	65	525.0
01-190	19.0	180	70	631.0
01-200	20.0	190	72	724.0
01-210	21.0	198	75	840.0
01-220	22.0	200	80	934.0
01-230	23.0	210	80	1056.0
01-240	24.0	224	90	1240.0
01-250	25.0	235	92	1436.0
01-260	26.0	245	95	1600.0
01-270	27.0	250	100	1750.0
01-290	29.0	270	110	2200.0
01-300	30.0	280	112	2420.0
01-320	32.0	315	125	3090.0
01-360	36.0	355	160	4585.0

ITEM NO.	SIZE (inch)	L (mm)	S (mm)	⚖️ (g)
01-0.05	0.05	40	12	0.6
01-1/16	1/16	45	14	0.9
01-5/64	5/64	50	16	1.8
01-3/32	3/32	56	18	3.2
01-7/64	7/64	59	19	4.0
01-1/8	1/8	63	20	5.0
01-9/64	9/64	65	22	7.0
01-5/32	5/32	70	25	10.0
01-3/16	3/16	80	28	18.0
01-7/32	7/32	85	30	24.0
01-1/4	1/4	90	32	33.0
01-9/32	9/32	95	34	43.0
01-5/16	5/16	100	36	60.0
01-3/8	3/8	112	40	105.0
01-7/16	7/16	118	42	136.0
01-1/2	1/2	125	45	190.0
01-9/16	9/16	140	56	275.0
01-5/8	5/8	160	63	387.0
01-11/16	11/16	170	66	498.0
01-3/4	3/4	180	70	631.0
01-7/8	7/8	200	80	953.0
01-1	1	235	90	1444.0

HEX KEY



LONG ARM SERIES

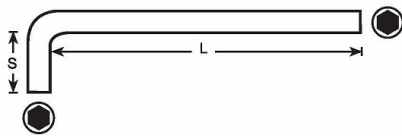
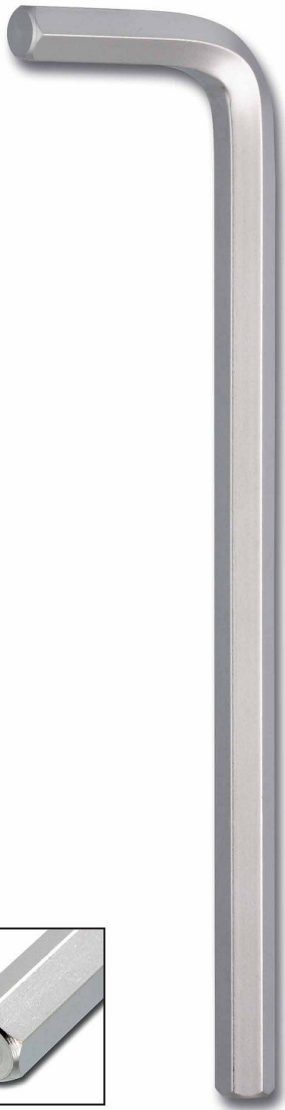

ITEM NO.	SIZE (mm)	L (mm)	S (mm)	⚖️ (g)
02-007	0.7	66	8	0.3
02-009	0.9	69	10	0.5
02-010	1.0	69	10	0.5
02-012	1.2	70	11	0.8
02-013	1.3	72	12	0.9
02-015	1.5	77	14	1.4
02-020	2.0	83	16	2.5
02-025	2.5	90	18	4.6
02-030	3.0	96	20	7.0
02-035	3.5	102	22	10.0
02-040	4.0	105	25	13.5
02-045	4.5	112	26	19.0
02-050	5.0	115	28	24.0
02-055	5.5	124	30	32.0
02-060	6.0	133	32	40.0
02-070	7.0	141	34	58.0
02-080	8.0	154	36	83.0
02-090	9.0	156	38	114.0
02-100	10.0	170	40	143.0
02-110	11.0	188	42	185.0
02-120	12.0	206	45	250.0
02-130	13.0	220	50	311.0
02-140	14.0	230	54	385.0
02-150	15.0	235	56	447.0
02-160	16.0	240	58	521.0
02-170	17.0	250	60	616.0
02-180	18.0	265	65	730.0
02-190	19.0	280	70	864.0
02-200	20.0	290	70	985.0
02-210	21.0	295	75	1120.0
02-220	22.0	300	80	1260.0
02-230	23.0	315	80	1430.0
02-240	24.0	330	90	1655.0
02-250	25.0	340	92	1850.0
02-260	26.0	350	95	2060.0
02-270	27.0	360	100	2290.0
02-290	29.0	380	110	2820.0
02-300	30.0	390	112	3090.0
02-320	32.0	400	125	3680.0
02-360	36.0	460	160	5490.0

ITEM NO.	SIZE (inch)	L (mm)	S (mm)	⚖️ (g)
02-0.05	0.05	72	12	0.9
02-1/16	1/16	77	14	1.4
02-5/64	5/64	83	16	2.5
02-3/32	3/32	90	18	4.6
02-7/64	7/64	94	19	6.0
02-1/8	1/8	96	20	7.4
02-9/64	9/64	102	22	10.0
02-5/32	5/32	105	24	13.5
02-3/16	3/16	115	28	22.0
02-7/32	7/32	124	30	32.0
02-1/4	1/4	133	32	43.5
02-9/32	9/32	141	34	61.0
02-5/16	5/16	154	36	83.0
02-3/8	3/8	170	40	130.0
02-7/16	7/16	188	42	195.0
02-1/2	1/2	206	45	276.0
02-9/16	9/16	230	56	398.0
02-5/8	5/8	250	60	534.0
02-11/16	11/16	260	65	678.0
02-3/4	3/4	280	70	870.0
02-7/8	7/8	300	80	1285.0
02-1	1	340	92	1910.0



HEX KEY

EXTRA LONG ARM SERIES

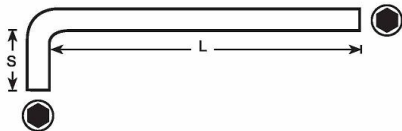

ITEM NO.	SIZE (mm)	L (mm)	S (mm)	(g)
03-015	1.5	90	14	1.5
03-020	2.0	100	15	3.0
03-025	2.5	112	18	5.3
03-030	3.0	126	20	8.3
03-035	3.5	134	22	13.0
03-040	4.0	142	25	18.0
03-045	4.5	150	26	24.0
03-050	5.0	160	28	32.0
03-055	5.5	170	30	41.0
03-060	6.0	180	32	51.0
03-070	7.0	190	34	76.0
03-080	8.0	200	36	102.0
03-090	9.0	210	38	136.0
03-100	10.0	224	40	178.0
03-110	11.0	236	42	230.0
03-120	12.0	250	45	290.0
03-130	13.0	265	50	362.0
03-140	14.0	280	55	450.0
03-150	15.0	295	58	540.0
03-160	16.0	305	60	630.0
03-170	17.0	320	63	753.0
03-180	18.0	340	65	892.0
03-190	19.0	360	70	1060.0
03-200	20.0	370	72	1205.0
03-210	21.0	380	75	1370.0
03-220	22.0	400	80	1585.0

ITEM NO.	SIZE (inch)	L (mm)	S (mm)	(g)
03-1/16	1/16	90	14	1.5
03-5/64	5/64	100	15	3.0
03-3/32	3/32	112	18	5.3
03-7/64	7/64	118	19	7.0
03-1/8	1/8	126	20	9.0
03-9/64	9/64	134	22	14.0
03-5/32	5/32	142	25	18.0
03-3/16	3/16	160	28	32.0
03-7/32	7/32	170	30	41.0
03-1/4	1/4	180	32	58.0
03-9/32	9/32	190	34	76.0
03-5/16	5/16	200	36	102.0
03-3/8	3/8	224	40	165.0
03-7/16	7/16	236	42	235.0
03-1/2	1/2	250	45	324.0
03-9/16	9/16	280	55	465.0
03-5/8	5/8	320	63	660.0
03-11/16	11/16	340	66	845.0
03-3/4	3/4	360	70	1065.0
03-7/8	7/8	400	80	1615.0
03-1	1	460	92	2425.0

BALL POINT

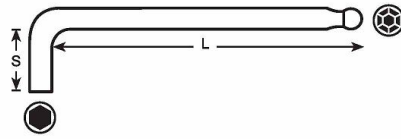

SHORT ARM SERIES

ITEM NO.	SIZE (mm)	L (mm)	S (mm)	⚖️ (g)
30-015	1.5	45	14	0.9
30-020	2.0	50	16	1.8
30-025	2.5	56	18	3.2
30-030	3.0	63	20	5.0
30-040	4.0	70	25	10.0
30-050	5.0	80	28	18.0
30-060	6.0	90	32	30.0
30-080	8.0	100	36	60.0
30-100	10.0	112	40	105.0

LONG ARM SERIES

ITEM NO.	SIZE (mm)	L (mm)	S (mm)	⚖️ (g)
31-013	1.3	72	12	0.9
31-015	1.5	77	14	1.4
31-020	2.0	83	16	2.5
31-025	2.5	90	18	4.3
31-030	3.0	96	20	6.8
31-035	3.5	102	22	10.0
31-040	4.0	105	24	13.5
31-045	4.5	112	25	19.0
31-050	5.0	115	26	23.0
31-055	5.5	124	28	30.3
31-060	6.0	133	30	38.7
31-070	7.0	137	34	57.0
31-080	8.0	154	36	79.0
31-100	10.0	170	40	138.0
31-120	12.0	206	45	251.0
31-140	14.0	230	54	385.0
31-170	17.0	250	60	616.0
31-190	19.0	280	70	864.0



ITEM NO.	SIZE (inch)	L (mm)	S (mm)	⚖️ (g)
31-1/16	1/16	77	14	1.4
31-5/64	5/64	83	16	2.5
31-3/32	3/32	90	18	3.8
31-7/64	7/64	94	19	6.0
31-1/8	1/8	96	20	7.4
31-9/64	9/64	102	22	10.0
31-5/32	5/32	105	24	13.5
31-3/16	3/16	115	26	20.7
31-7/32	7/32	124	28	30.5
31-1/4	1/4	133	30	43.5
31-5/16	5/16	154	36	77.0
31-3/8	3/8	170	40	125.0
31-1/2	1/2	207	45	251.0
31-9/16	9/16	230	56	385.0



BALL POINT

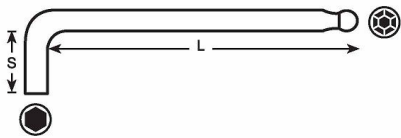
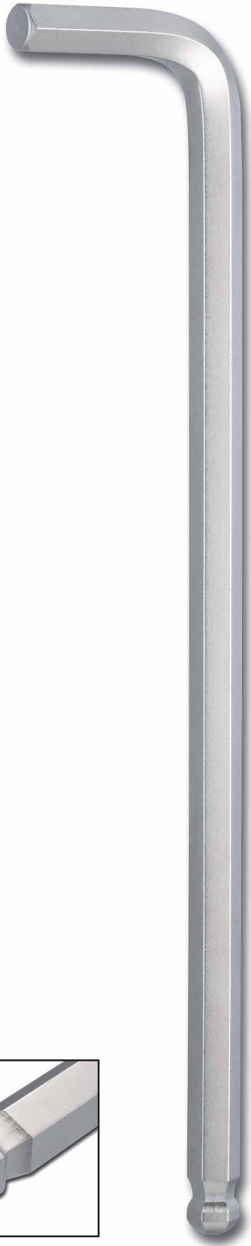

EXTRA LONG SERIES

ITEM NO.	SIZE (mm)	L (mm)	S (mm)	⚖️ (g)
33-015	1.5	90	14	1.5
33-020	2.0	100	15	3.0
33-025	2.5	112	18	5.3
33-030	3.0	126	20	8.3
33-040	4.0	142	25	17.6
33-050	5.0	160	28	31.0
33-055	5.5	170	30	40.0
33-060	6.0	180	32	51.0
33-070	7.0	190	34	76.0
33-080	8.0	200	36	101.0
33-090	9.0	212	38	137.0
33-100	10.0	224	40	175.0
33-120	12.0	250	45	293.0
33-140	14.0	280	55	457.0
33-170	17.0	320	63	753.0
33-190	19.0	360	70	1073.0

ITEM NO.	SIZE (inch)	L (mm)	S (mm)	⚖️ (g)
33-0.05	0.05	80	13	1.0
33-1/16	1/16	90	14	1.5
33-5/64	5/64	100	15	3.0
33-3/32	3/32	112	18	4.7
33-1/8	1/8	126	20	9.5
33-5/32	5/32	142	25	17.0
33-3/16	3/16	160	28	28.0
33-7/32	7/32	170	30	40.0
33-1/4	1/4	180	32	56.0
33-5/16	5/16	200	36	98.0
33-3/8	3/8	224	40	159.0
33-1/2	1/2	250	45	293.0
33-9/16	9/16	280	55	457.0

STAR KEY WRENCH



SHORT ARM SERIES

ITEM NO.	SIZE	L (mm)	S (mm)	△ (g)
11-06	T06	40	11	2.0
11-07	T07	44	12	2.0
11-08	T08	50	15	3.5
11-09	T09	55	18	3.5
11-10	T10	60	20	4.0
11-15	T15	64	22	6.0
11-20	T20	68	23	8.4
11-25	T25	72	24	12.0
11-27	T27	78	25	15.0
11-30	T30	83	26	20.0
11-40	T40	89	28	33.0
11-45	T45	96	31	48.1
11-50	T50	105	35	67.0
11-55	T55	116	40	115.0
11-60	T60	125	45	190.0
11-70	T70	140	55	318.0

LONG ARM SERIES

ITEM NO.	SIZE	L (mm)	S (mm)	△ (g)
12-06	T06	66	16	2.8
12-07	T07	71	16	3.1
12-08	T08	76	16	4.9
12-09	T09	80	16	5.2
12-10	T10	86	17	6.0
12-15	T15	90	18	8.0
12-20	T20	95	19	11.0
12-25	T25	100	20	15.0
12-27	T27	105	21	20.0
12-30	T30	114	24	31.0
12-40	T40	124	26	44.0
12-45	T45	137	29	65.0
12-50	T50	152	32	90.0
12-55	T55	171	35	184.0
12-60	T60	190	38	275.0

EXTRA LONG ARM SERIES

ITEM NO.	SIZE	L (mm)	S (mm)	△ (g)
13-10	T10	90	14	5.1
13-15	T15	100	16	8.0
13-20	T20	112	18	12.0
13-25	T25	126	20	17.0
13-27	T27	142	25	25.0
13-30	T30	160	28	40.0
13-40	T40	180	32	61.0
13-45	T45	200	36	90.0
13-50	T50	224	40	127.0
13-55	T55	250	45	246.0
13-60	T60	280	55	384.0

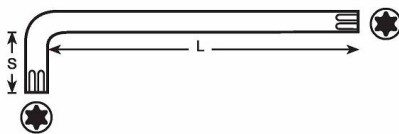

BALL POINT STAR KEY WRENCH

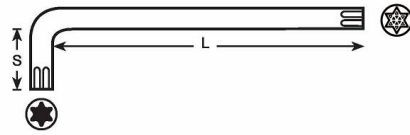

EXTRA LONG ARM SERIES

ITEM NO.	SIZE	L (mm)	S (mm)	(g)
43-10	T10	90	14	5.1
43-15	T15	100	16	8.0
43-20	T20	112	18	12.0
43-25	T25	126	20	17.0
43-27	T27	142	25	25.0
43-30	T30	160	28	40.0
43-40	T40	180	32	61.0
43-45	T45	200	36	90.0
43-50	T50	224	40	127.0



EXTRA LONG ARM STAR KEY (Plastic Holder + Slide Card)

ITEM NO.	SET	SIZE	PACKING
463-9SC	9pcs	T10, T15, T20, T25, T27, T30, T40, T45, T50	36/19.3/1.8



TAMPER STAR KEY WRENCH

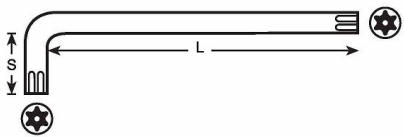

SHORT ARM SERIES

ITEM NO.	SIZE	L (mm)	S (mm)	(g)
H11-06	T06	40	11	2.0
H11-07	T07	44	12	2.0
H11-08	T08	50	15	3.5
H11-09	T09	55	18	3.5
H11-10	T10	60	20	4.0
H11-15	T15	64	22	6.0
H11-20	T20	68	23	8.4
H11-25	T25	72	24	12.0
H11-27	T27	78	25	15.0
H11-30	T30	83	26	25.0
H11-40	T40	89	28	33.0
H11-45	T45	96	31	48.0
H11-50	T50	105	35	65.0
H11-55	T55	116	40	110.0
H11-60	T60	125	45	190.0

LONG ARM SERIES

ITEM NO.	SIZE	L (mm)	S (mm)	(g)
H12-06	T06	66	16	2.8
H12-07	T07	71	16	3.1
H12-08	T08	76	16	4.9
H12-09	T09	80	16	5.2
H12-10	T10	86	17	6.0
H12-15	T15	90	18	8.0
H12-20	T20	95	19	11.0
H12-25	T25	100	20	15.0
H12-27	T27	105	21	20.0
H12-30	T30	114	24	32.0
H12-40	T40	124	26	44.0
H12-45	T45	137	29	65.0
H12-50	T50	152	32	90.0
H12-55	T55	171	35	184.0
H12-60	T60	190	38	275.0

EXTRA LONG ARM SERIES

ITEM NO.	SIZE	L (mm)	S (mm)	(g)
H13-10	T10	90	14	5.1
H13-15	T15	100	16	8.0
H13-20	T20	112	18	12.0
H13-25	T25	126	20	17.0
H13-27	T27	142	25	25.0
H13-30	T30	160	28	43.0
H13-40	T40	180	32	61.0
H13-45	T45	200	36	90.0
H13-50	T50	224	40	127.0
H13-55	T55	250	45	246.0
H13-60	T60	280	55	384.0

BALL ON BALL POINT HEX KEY WRENCH



LONG ARM SERIES

ITEM NO.	SIZE (mm)	L (mm)	S (mm)	(g)
B31-030	3.0	96	20	6.8
B31-040	4.0	105	24	13.5
B31-050	5.0	115	26	26.0
B31-055	5.5	124	28	32.0
B31-060	6.0	133	30	40.0
B31-070	7.0	137	34	57.0
B31-080	8.0	154	36	83.0
B31-090	9.0	160	38	114.0
B31-100	10.0	170	40	143.0

ITEM NO.	SIZE (inch)	L (mm)	S (mm)	(g)
B31-1/8	1/8	96	20	7.4
B31-9/64	9/64	102	22	10.0
B31-5/32	5/32	105	24	13.5
B31-3/16	3/16	115	26	20.7
B31-7/32	7/32	124	28	30.5
B31-1/4	1/4	133	30	43.5
B31-5/16	5/16	154	36	77.0
B31-3/8	3/8	170	40	125.0

The joint of the screws and wrench make them workable in the gap.

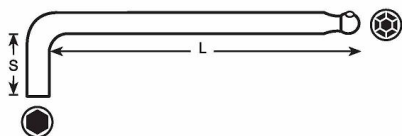

EXTRA LONG ARM SERIES

ITEM NO.	SIZE (mm)	L (mm)	S (mm)	(g)
B33-030	3.0	126	20	8.3
B33-040	4.0	142	25	17.6
B33-050	5.0	160	28	31.0
B33-055	5.5	170	30	40.0
B33-060	6.0	180	32	51.0
B33-070	7.0	190	34	76.0
B33-080	8.0	200	36	101.0
B33-090	9.0	210	38	136.0
B33-100	10.0	224	40	175.0

ITEM NO.	SIZE (inch)	L (mm)	S (mm)	(g)
B33-1/8	1/8	126	20	9.5
B33-5/32	5/32	142	25	17.0
B33-3/16	3/16	160	28	28.0
B33-7/32	7/32	170	30	40.0
B33-1/4	1/4	180	32	56.0
B33-5/16	5/16	200	36	98.0
B33-3/8	3/8	224	40	159.0



STRIPED HEX KEY

Patent

LONG ARM SERIES

ITEM NO.	SIZE (mm)	L (mm)	S (mm)	⚖️ (g)
A02-015	1.5	77	14	1.4
A02-020	2.0	83	16	2.5
A02-025	2.5	90	18	4.3
A02-030	3.0	96	20	6.8
A02-035	3.5	102	22	10.0
A02-040	4.0	105	24	13.5
A02-045	4.5	112	25	19.0
A02-050	5.0	115	26	26.0
A02-055	5.5	124	28	32.0
A02-060	6.0	133	30	40.0
A02-070	7.0	137	33	57.0
A02-080	8.0	154	36	83.0
A02-090	9.0	156	38	114.0
A02-100	10.0	170	40	143.0
A02-120	12.0	206	45	251.0
A02-140	14.0	230	54	385.0
A02-170	17.0	250	60	615.0
A02-190	19.0	280	70	876.0

ITEM NO.	SIZE (inch)	L (mm)	S (mm)	⚖️ (g)
A02-1/16	1/16	77	14	1.4
A02-5/64	5/64	83	16	2.5
A02-3/32	3/32	90	18	4.6
A02-7/64	7/64	94	19	6.0
A02-1/8	1/8	96	20	7.4
A02-9/64	9/64	102	22	10.0
A02-5/32	5/32	105	24	13.5
A02-3/16	3/16	115	26	20.7
A02-7/32	7/32	124	28	30.5
A02-1/4	1/4	133	30	43.5
A02-5/16	5/16	154	36	77.4
A02-3/8	3/8	170	40	125.0
A02-1/2	1/2	206	45	276.0
A02-9/16	9/16	230	56	400.0
A02-5/8	5/8	250	60	540.0
A02-3/4	3/4	280	70	876.0

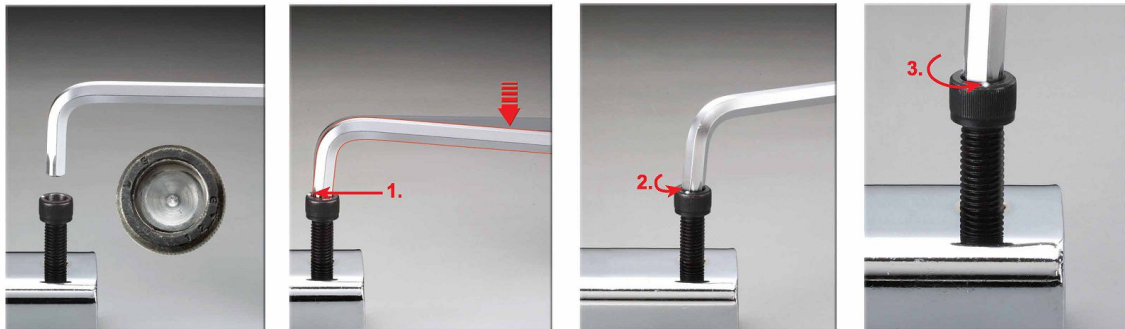
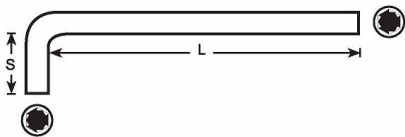

Striped Hex Key Wrench can drive a inner hexagon screws and even can fasten or release a round-off one.



EXTRA LONG ARM SERIES

ITEM NO.	SIZE (mm)	L (mm)	S (mm)	⚖️ (g)
A03-015	1.5	90	14	1.5
A03-020	2.0	100	15	3.0
A03-025	2.5	112	18	5.3
A03-030	3.0	126	20	8.3
A03-040	4.0	140	25	17.6
A03-050	5.0	160	28	31.0
A03-055	5.5	170	30	40.0
A03-060	6.0	180	32	51.0
A03-070	7.0	190	34	76.0
A03-080	8.0	200	36	101.0
A03-100	10.0	224	40	175.0
A03-120	12.0	250	45	293.0
A03-140	14.0	280	55	450.0
A03-170	17.0	320	63	753.0
A03-190	19.0	360	70	1073.0

ITEM NO.	SIZE (inch)	L (mm)	S (mm)	⚖️ (g)
A03-1/16	1/16	90	14	1.5
A03-5/64	5/64	100	15	3.0
A03-3/32	3/32	112	18	4.7
A03-1/8	1/8	126	20	9.5
A03-5/32	5/32	142	25	17.0
A03-3/16	3/16	160	28	28.0
A03-7/32	7/32	170	30	40.0
A03-1/4	1/4	180	32	56.0
A03-5/16	5/16	200	36	98.0
A03-3/8	3/8	224	40	159.0
A03-1/2	1/2	250	45	325.0
A03-9/16	9/16	280	55	466.0
A03-5/8	5/8	320	63	660.0
A03-3/4	3/4	360	70	1073.0

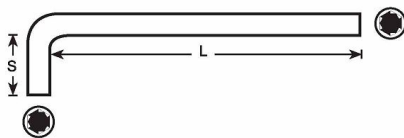



BALL POINT + STRIPED HEX KEY

Patent

LONG ARM SERIES

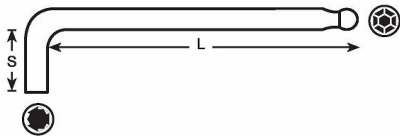
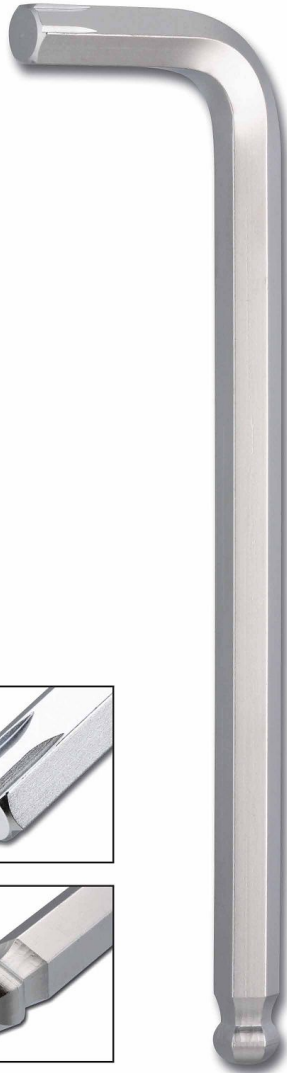

ITEM NO.	SIZE (mm)	L (mm)	S (mm)	(g)
A31-015	1.5	77	14	1.4
A31-020	2.0	83	16	2.5
A31-025	2.5	90	18	4.3
A31-030	3.0	96	20	6.8
A31-035	3.5	102	22	10.0
A31-040	4.0	105	24	13.5
A31-045	4.5	112	25	19.0
A31-050	5.0	115	26	26.0
A31-055	5.5	124	28	32.0
A31-060	6.0	133	30	40.0
A31-070	7.0	137	34	57.0
A31-080	8.0	154	36	83.0
A31-100	10.0	170	40	143.0
A31-120	12.0	206	45	251.0
A31-140	14.0	230	54	385.0
A31-170	17.0	250	60	615.0
A31-190	19.0	280	70	876.0

ITEM NO.	SIZE (inch)	L (mm)	S (mm)	(g)
A31-1/16	1/16	77	14	1.4
A31-5/64	5/64	83	16	2.5
A31-3/32	3/32	90	18	4.6
A31-7/64	7/64	94	19	6.0
A31-1/8	1/8	96	20	7.4
A31-9/64	9/64	102	22	10.0
A31-5/32	5/32	105	24	13.5
A31-3/16	3/16	115	26	20.7
A31-7/32	7/32	124	28	30.5
A31-1/4	1/4	133	30	43.5
A31-5/16	5/16	154	36	77.0
A31-3/8	3/8	170	40	125.0
A31-1/2	1/2	207	45	276.0
A31-9/16	9/16	230	56	400.0
A31-5/8	5/8	250	60	540.0
A31-3/4	3/4	280	70	876.0



EXTRA LONG SERIES

ITEM NO.	SIZE (mm)	L (mm)	S (mm)	⚖️ (g)
A33-015	1.5	90	14	1.5
A33-020	2.0	100	15	3.0
A33-025	2.5	112	18	5.3
A33-030	3.0	126	20	8.3
A33-040	4.0	142	25	17.6
A33-050	5.0	160	28	31.0
A33-055	5.5	170	30	40.0
A33-060	6.0	180	32	51.0
A33-070	7.0	190	34	76.0
A33-080	8.0	200	36	101.0
A33-100	10.0	224	40	175.0
A33-120	12.0	250	45	293.0
A33-140	14.0	280	55	450.0
A33-170	17.0	320	63	753.0
A33-190	19.0	360	70	1073.0

ITEM NO.	SIZE (inch)	L (mm)	S (mm)	⚖️ (g)
A33-1/16	1/16	90	14	1.5
A33-5/64	5/64	100	15	3.0
A33-3/32	3/32	112	18	4.7
A33-1/8	1/8	126	20	9.5
A33-5/32	5/32	142	25	17.0
A33-3/16	3/16	160	28	28.0
A33-7/32	7/32	170	30	40.0
A33-1/4	1/4	180	32	56.0
A33-5/16	5/16	200	36	98.0
A33-3/8	3/8	224	40	159.0
A33-1/2	1/2	250	45	293.0
A33-9/16	9/16	280	55	457.0
A33-5/8	5/8	320	63	660.0
A33-3/4	3/4	360	70	1073.0

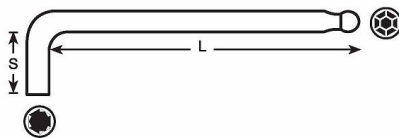



SPLINE KEY

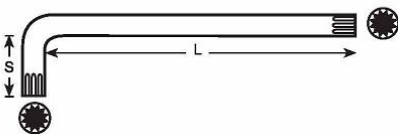

SHORT ARM SERIES

ITEM NO.	SIZE	L (mm)	S (mm)	(g)
21-003	M3	54	18	4.0
21-004	M4	63	20	8.0
21-005	M5	72	25	15.0
21-006	M6	80	28	23.0
21-008	M8	90	32	40.0
21-009	M9	95	34	67.0
21-010	M10	100	36	90.0
21-012	M12	112	40	130.0
21-014	M14	125	45	200.0
21-016	M16	140	55	310.0
21-018	M18	140	55	350.0

EXTRA LONG SERIES

ITEM NO.	SIZE	L (mm)	S (mm)	(g)
23-003	M3	90	14	7.0
23-004	M4	110	18	15.0
23-005	M5	142	25	30.0
23-006	M6	160	28	43.0
23-008	M8	180	32	86.0
23-009	M9	200	36	120.0
23-010	M10	215	40	162.0
23-012	M12	230	45	230.0



SPLINE KEY WRENCH SET (Plastic Holder + Slide Card)

ITEM NO.	SET	SIZE	PACKING
281-8V	8pcs	SHORT ARM: M3, M4, M5, M6, M8, M9, M10, M12	36/17.2/0.9
283-8V	8pcs	EXTRA LONG: M3, M4, M5, M6, M8, M9, M10, M12	24/19.5/1.3

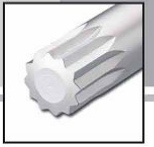

EXTRA LONG SPLINE KEY SET

(Plastic Holder + Slide Card)

ITEM NO.	SET	SIZE	PACKING
P283-8	8pcs	M3, M4, M5, M6, M8, M9, M10, M12	24/19.5/1.3



SHORT ARM SPLINE KEY WRENCH SET

(Pouch bag)

ITEM NO.	SET	SIZE	PACKING
252-5	5pcs	M5, M6, M8, M10, M12	48/16.8/0.5
252-7	7pcs	M4, M5, M6, M8, M10, M12, M14	36/20.0/0.5



SHORT ARM SPLINE KEY WRENCH SET

(Metal Case + Slide Card)

ITEM NO.	SET	SIZE	PACKING
241-M5	5pcs	M5, M6, M8, M10, M12	36/20.5/1.0



FOLDING TYPE SPLINE KEY WRENCH SET

ITEM NO.	SET	SIZE	PACKING
213-5	5pcs	M5, M6, M8, M10, M12	40/19.2/0.6



RIBE SCREW WRENCH



EXTRA LONG SERIES

ITEM NO.	SIZE	L (mm)	S (mm)	⚖️ (g)
63-030	MP3	100	16	6.0
63-040	MP4	112	18	13.0
63-050	MP5	126	20	25.0
63-060	MP6	142	25	38.0
63-070	MP7	160	28	61.0
63-080	MP8	180	32	85.0
63-090	MP9	200	36	121.0
63-100	MP10	224	40	166.0
63-110	MP11	238	43	215.0
63-120	MP12	250	45	268.0
63-140	MP14	280	55	415.0
63-160	MP16	310	63	604.0
63-180	MP18	340	70	840.0

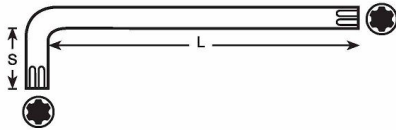

EXTRA LONG RIBE SCREW WRENCH (Plastic Holder + Slide Card)

ITEM NO.	SET	SIZE	PACKING
6353-7VC	7pcs	MP4, MP5, MP6, MP7, MP8, MP9, MP10	36/22.0/1.8

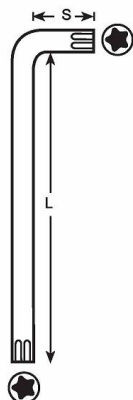
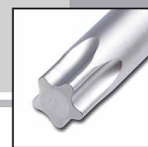

★ ★ EXTRA LONG

STAR KEY 5-LOBE WRENCH

ITEM NO.	SIZE	L (mm)	S (mm)	(g)
53-08	TS8	70	14	4.0
53-09	TS9	80	14	4.0
53-10	TS10	90	14	6.0
53-15	TS15	100	16	8.0
53-20	TS20	112	18	12.0
53-25	TS25	126	20	17.0
53-27	TS27	142	25	25.0
53-30	TS30	160	28	40.0
53-40	TS40	180	32	61.0
53-45	TS45	200	36	90.0
53-50	TS50	224	40	127.0

★ ★ EXTRA LONG

TAMPER STAR KEY 5-LOBE WRENCH

ITEM NO.	SIZE	L (mm)	S (mm)	(g)
H53-08	TS8	70	14	4.0
H53-09	TS9	80	14	4.0
H53-10	TS10	90	14	6.0
H53-15	TS15	100	16	8.0
H53-20	TS20	112	18	12.0
H53-25	TS25	126	20	17.0
H53-27	TS27	142	25	25.0
H53-30	TS30	160	28	40.0
H53-40	TS40	180	32	61.0
H53-45	TS45	200	36	90.0
H53-50	TS50	224	40	127.0

★ ★ EXTRA LONG

STAR KEY 5-LOBE WRENCH SET (Plastic Holder + Slide Card)

ITEM NO.	SET	SIZE	PACKING
563-9SC	9pcs	TS10, TS15, TS20, TS25, TS27, TS30, TS40, TS45, TS50	36/19.3/1.8



★ ★ EXTRA LONG

TAMPER STAR KEY 5-LOBE WRENCH SET (Plastic Holder + Slide Card)

ITEM NO.	SET	SIZE	PACKING
H563-9SC	9pcs	TS10, TS15, TS20, TS25, TS27, TS30, TS40, TS45, TS50	36/19.3/1.8



STAR KEY 5-LOBE WRENCH

Patent

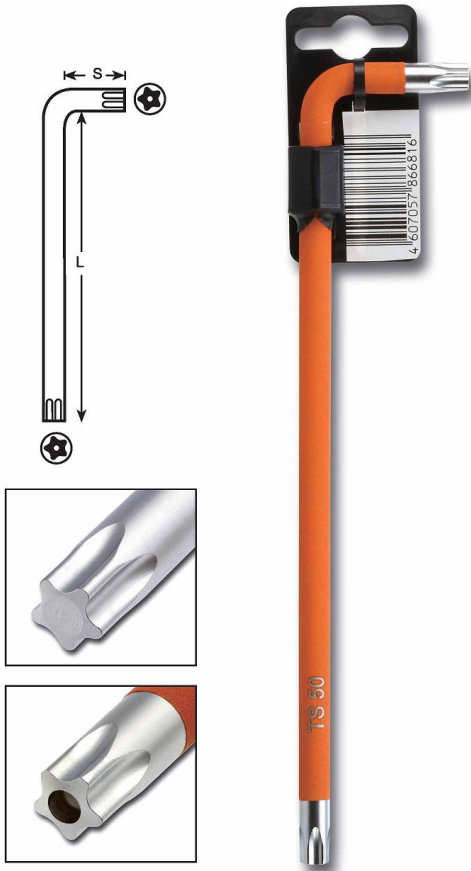

★ ★ EXTRA LONG STAR KEY 5-LOBE WRENCH

ITEM NO.	SIZE	L (mm)	S (mm)	(g)
P53-08	TS8	70	14	4.0
P53-09	TS9	80	14	4.0
P53-10	TS10	90	14	6.0
P53-15	TS15	100	16	8.0
P53-20	TS20	112	18	12.0
P53-25	TS25	126	20	17.0
P53-27	TS27	142	25	25.0
P53-30	TS30	160	28	40.0
P53-40	TS40	180	32	61.0
P53-45	TS45	200	36	90.0
P53-50	TS50	224	40	127.0

★ ★ EXTRA LONG TAMPER STAR KEY 5-LOBE WRENCH

ITEM NO.	SIZE	L (mm)	S (mm)	(g)
HP53-08	TS8	70	14	4.0
HP53-09	TS9	80	14	4.0
HP53-10	TS10	90	14	6.0
HP53-15	TS15	100	16	8.0
HP53-20	TS20	112	18	12.0
HP53-25	TS25	126	20	17.0
HP53-27	TS27	142	25	25.0
HP53-30	TS30	160	28	40.0
HP53-40	TS40	180	32	61.0
HP53-45	TS45	200	36	90.0
HP53-50	TS50	224	40	127.0



★ ★ EXTRA LONG STAR KEY 5-LOBE WRENCH SET (Plastic Holder + Slide Card)

ITEM NO.	SET	SIZE	PACKING
P563-9SC	9pcs	TS10, TS15, TS20, TS25, TS27, TS30, TS40, TS45, TS50	36/19.4/1.8

★ ★ EXTRA LONG TAMPER STAR KEY 5-LOBE WRENCH SET (Plastic Holder + Slide Card)

ITEM NO.	SET	SIZE	PACKING
HP563-9SC	9pcs	TS10, TS15, TS20, TS25, TS27, TS30, TS40, TS45, TS50	36/19.4/1.8



● SHORT ARM HEX KEY (Plastic Holder + Slide Card)

ITEM NO.	SET	SIZE (mm)(inch)	PACKING
051-7V	7pcs	2.5, 3, 4, 5, 6, 8, 10	72/19.0/1.3
051-S8V	8pcs	1.5, 2, 2.5, 3, 4, 5, 5.5, 6	144/17.5/1.5
051-9V	9pcs	1.5, 2, 2.5, 3, 4, 5, 6, 8, 10	72/21.5/1.5
051-0V	10pcs	1.5, 2, 2.5, 3, 4, 5, 5.5, 6, 8, 10	72/22.5/1.5
051-8V	8pcs	2, 2.5, 3, 4, 5, 6, 8, 10	72/19.5/1.3
051-7VH	7pcs	3/32, 1/8, 5/32, 3/16, 1/4, 5/16, 3/8	72/19.0/1.3
051-S8VH	8pcs	1/16, 5/64, 3/32, 1/8, 5/32, 3/16, 7/32, 1/4	144/17.5/1.5
051-9VH	9pcs	1/16, 5/64, 3/32, 1/8, 5/32, 3/16, 1/4, 5/16, 3/8	72/21.5/1.5
051-0VH	10pcs	1/16, 5/64, 3/32, 1/8, 5/32, 3/16, 7/32, 1/4, 5/16, 3/8	72/22.5/1.5
051-S7V	7pcs	1.5, 2, 2.5, 3, 4, 5, 6	144/12.8/1.3
051-S7VH	7pcs	1/16, 5/64, 3/32, 1/8, 5/32, 3/16, 1/4	144/12.6/1.3
051-S6V	6pcs	2, 2.5, 3, 4, 5, 6	144/12.7/1.3



● 25PCS SUPER LONG HEAVY DUTY HEX KEY (Vinyl Pouch)

ITEM NO.	SET	SIZE (mm)(inch)	PACKING
052-25VH	25pcs	S: 1.5, 2, 2.5, 3, 4, 4.5, 5, 5.5, 6, 7, 8, 9, 10 L: 1/16, 5/64, 3/32, 7/64, 1/8, 9/64, 5/32, 3/16, 7/32, 1/4, 5/16, 3/8	24/20.0/0.8



● WALLET TYPE HEX KEY WRENCH SET

ITEM NO.	SET	SIZE (mm)(inch)	PACKING
055-0V	10pcs	1.27, 1.5, 2, 2.5, 3, 4, 5, 6, 8, 10	60/18.5/0.73
055-0VH	10pcs	1/16, 5/64, 3/32, 1/8, 5/32, 3/16, 7/32, 1/4, 5/16, 3/8	60/18.5/0.73
055-25V	25pcs	1.5, 2, 2.5, 3, 4, 4.5, 5, 5.5, 6, 7, 8, 9, 10 1/16, 5/64, 3/32, 7/64, 1/8, 9/64, 5/32, 3/16, 7/32, 1/4, 5/16, 3/8	24/21.5/0.85



HEX KEY



● LONG ARM HEX KEY (Plastic Holder + Slide Card)

ITEM NO.	SET	SIZE (mm)(inch)	PACKING
201-SS6V	6pcs	1.5, 2, 2.5, 3, 4, 5	144/13.5/1.5
201-S6V	6pcs	2, 2.5, 3, 4, 5, 6	144/19.0/1.5
201-S7V	7pcs	1.5, 2, 2.5, 3, 4, 5, 6	144/19.3/1.5
201-S8V	8pcs	1.5, 2, 2.5, 3, 4, 5, 5.5, 6	144/20.3/1.5
201-M8V	8pcs	1.5, 2, 2.5, 3, 4, 5, 6, 8	48/11.8/0.8
201-7V	7pcs	2.5, 3, 4, 5, 6, 8, 10	48/18.0/0.8
201-8V	8pcs	2, 2.5, 3, 4, 5, 6, 8, 10	48/18.6/0.8
201-9V	9pcs	1.5, 2, 2.5, 3, 4, 5, 6, 8, 10	48/18.7/0.8
201-0V	10pcs	1.5, 2, 2.5, 3, 4, 5, 5.5, 6, 8, 10	48/20.0/0.8
201-S8VH	8pcs	1/16, 5/64, 3/32, 1/8, 5/32, 3/16, 7/32, 1/4	144/20.3/1.5
201-7VH	7pcs	3/32, 1/8, 5/32, 3/16, 1/4, 5/16, 3/8	48/18.0/0.8
201-9VH	9pcs	1/16, 5/64, 3/32, 1/8, 5/32, 3/16, 1/4, 5/16, 3/8	48/18.7/0.8
201-0VH	10pcs	1/16, 5/64, 3/32, 1/8, 5/32, 3/16, 7/32, 1/4, 5/16, 3/8	48/20.0/0.8



● EXTRA LONG ARM HEX KEY (Plastic Holder + Slide Card)

ITEM NO.	SET	SIZE (mm)(inch)	PACKING
203-SS6V	6pcs	1.5, 2, 2.5, 3, 4, 5	144/12.9/1.7
203-S6V	6pcs	2, 2.5, 3, 4, 5, 6	144/20.0/1.7
203-S7V	7pcs	1.5, 2, 2.5, 3, 4, 5, 6	144/20.2/1.7
203-S8V	8pcs	1.5, 2, 2.5, 3, 4, 5, 5.5, 6	72/10.0/1.2
203-M8V	8pcs	1.5, 2, 2.5, 3, 4, 5, 6, 8	48/15.5/0.9
203-7V	7pcs	2.5, 3, 4, 5, 6, 8, 10	48/23.6/0.9
203-8V	8pcs	2, 2.5, 3, 4, 5, 6, 8, 10	48/24.0/0.9
203-9V	9pcs	1.5, 2, 2.5, 3, 4, 5, 6, 8, 10	48/24.0/0.9
203-0V	10pcs	1.5, 2, 2.5, 3, 4, 5, 5.5, 6, 8, 10	48/24.5/0.9
203-S8VH	8pcs	1/16, 5/64, 3/32, 1/8, 5/32, 3/16, 7/32, 1/4	72/10.0/1.2
203-7VH	7pcs	3/32, 1/8, 5/32, 3/16, 1/4, 5/16, 3/8	48/23.6/0.9
203-8VH	8pcs	5/64, 3/32, 1/8, 5/32, 3/16, 1/4, 5/16, 3/8	48/24.0/0.9
203-9VH	9pcs	1/16, 5/64, 3/32, 1/8, 5/32, 3/16, 1/4, 5/16, 3/8	48/24.0/0.9
203-0VH	10pcs	1/16, 5/64, 3/32, 1/8, 5/32, 3/16, 7/32, 1/4, 5/16, 3/8	48/24.5/0.9



LONG ARM BALL POINT (Plastic Holder + Slide Card)

ITEM NO.	SET	SIZE (mm)(inch)	PACKING
301-SS6V	6pcs	1.5, 2, 2.5, 3, 4, 5	144/13.5/1.5
301-S6V	6pcs	2, 2.5, 3, 4, 5, 6	144/19.0/1.5
301-S7V	7pcs	1.5, 2, 2.5, 3, 4, 5, 6	144/19.3/1.5
301-S8V	8pcs	1.5, 2, 2.5, 3, 4, 5, 5.5, 6	144/20.3/1.5
301-M8V	8pcs	1.5, 2, 2.5, 3, 4, 5, 6, 8	48/11.8/0.8
301-7V	7pcs	2.5, 3, 4, 5, 6, 8, 10	48/18.0/0.8
301-8V	8pcs	2, 2.5, 3, 4, 5, 6, 8, 10	48/18.6/0.8
301-9V	9pcs	1.5, 2, 2.5, 3, 4, 5, 6, 8, 10	48/18.7/0.8
301-0V	10pcs	1.5, 2, 2.5, 3, 4, 5, 5.5, 6, 8, 10	48/20.0/0.8
301-S8VH	8pcs	1/16, 5/64, 3/32, 1/8, 5/32, 3/16, 7/32, 1/4	144/20.3/1.5
301-7VH	7pcs	3/32, 1/8, 5/32, 3/16, 1/4, 5/16, 3/8	48/18.0/0.8
301-9VH	9pcs	1/16, 5/64, 3/32, 1/8, 5/32, 3/16, 1/4, 5/16, 3/8	48/18.7/0.8
301-0VH	10pcs	1/16, 5/64, 3/32, 1/8, 5/32, 3/16, 7/32, 1/4, 5/16, 3/8	48/20.0/0.8



EXTRA LONG BALL POINT (Plastic Holder + Slide Card)

ITEM NO.	SET	SIZE (mm)(inch)	PACKING
303-SS6V	6pcs	1.5, 2, 2.5, 3, 4, 5	144/12.9/1.7
303-S6V	6pcs	2, 2.5, 3, 4, 5, 6	144/20.0/1.7
303-S7V	7pcs	1.5, 2, 2.5, 3, 4, 5, 6	144/20.2/1.7
303-S8V	8pcs	1.5, 2, 2.5, 3, 4, 5, 5.5, 6	60/23.0/1.2
303-M8V	8pcs	1.5, 2, 2.5, 3, 4, 5, 6, 8	48/15.5/0.9
303-7V	7pcs	2.5, 3, 4, 5, 6, 8, 10	48/23.6/0.9
303-8V	8pcs	2, 2.5, 3, 4, 5, 6, 8, 10	48/24.0/0.9
303-9V	9pcs	1.5, 2, 2.5, 3, 4, 5, 6, 8, 10	48/24.0/0.9
303-0V	10pcs	1.5, 2, 2.5, 3, 4, 5, 5.5, 6, 8, 10	48/24.5/0.9
303-S8VH	8pcs	1/16, 5/64, 3/32, 1/8, 5/32, 3/16, 7/32, 1/4	72/10.0/1.2
303-7VH	7pcs	3/32, 1/8, 5/32, 3/16, 1/4, 5/16, 3/8	48/23.6/0.9
303-8VH	8pcs	5/64, 3/32, 1/8, 5/32, 3/16, 1/4, 5/16, 3/8	48/24.0/0.9
303-9VH	9pcs	1/16, 5/64, 3/32, 1/8, 5/32, 3/16, 1/4, 5/16, 3/8	48/24.0/0.9
303-0VH	10pcs	1/16, 5/64, 3/32, 1/8, 5/32, 3/16, 7/32, 1/4, 5/16, 3/8	48/24.5/0.9



HEX KEY

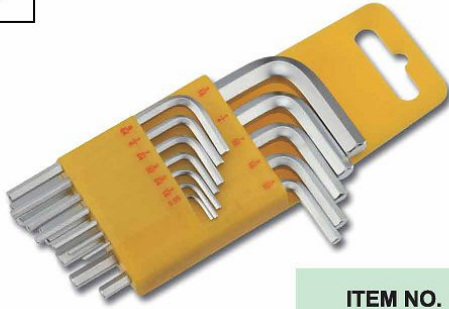

● SHORT ARM HEX KEY (Plastic Holder + Double Blister)

ITEM NO.	SET	SIZE (mm)(inch)	PACKING
0351-12VH	12pcs	0.05, 1/16, 5/64, 3/32, 7/64, 1/8, 9/64, 5/32, 3/16, 7/32, 1/4, 5/16	72/21.9/1.4
0351-M12VH	12pcs	1/16, 5/64, 3/32, 7/64, 1/8, 9/64, 5/32, 3/16, 7/32, 1/4, 5/16, 3/8	48/20.0/1.4
0351-13VH	13pcs	0.05, 1/16, 5/64, 3/32, 7/64, 1/8, 9/64, 5/32, 3/16, 7/32, 1/4, 5/16, 3/8	48/20.0/1.4
351-9V	9pcs	1.5, 2, 2.5, 3, 4, 5, 6, 8, 10	72/21.0/1.3
0351-L0V	10pcs	1.5, 2, 2.5, 3, 4, 5, 6, 8, 10, 12	36/17.5/1.0



● LONG ARM HEX KEY (Plastic Holder + Double Blister)

ITEM NO.	SET	SIZE (mm)(inch)	PACKING
0352-12VH	12pcs	0.05, 1/16, 5/64, 3/32, 7/64, 1/8, 9/64, 5/32, 3/16, 7/32, 1/4, 5/16	48/15.7/1.3
0352-M12VH	12pcs	1/16, 5/64, 3/32, 7/64, 1/8, 9/64, 5/32, 3/16, 7/32, 1/4, 5/16, 3/8	36/16.5/1.1
0352-13VH	13pcs	0.05, 1/16, 5/64, 3/32, 7/64, 1/8, 9/64, 5/32, 3/16, 7/32, 1/4, 5/16, 3/8	36/16.5/1.1
352-9V	9pcs	1.5, 2, 2.5, 3, 4, 5, 6, 8, 10	48/19.0/1.3
0352-L0V	10pcs	1.5, 2, 2.5, 3, 4, 5, 6, 8, 10, 12	30/19.5/1.2

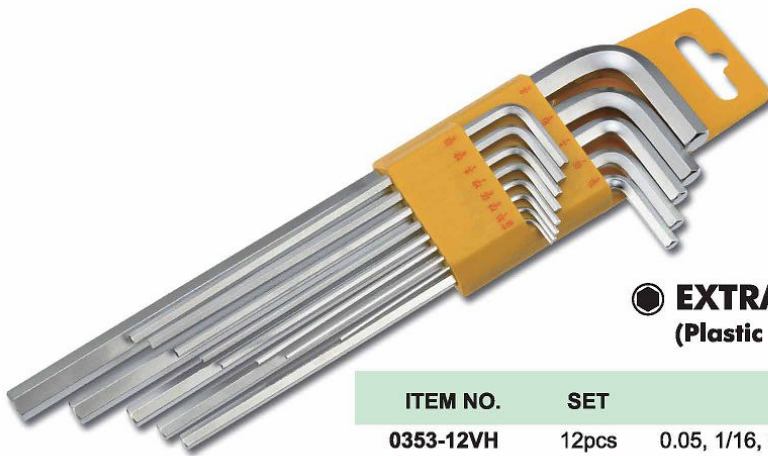

● EXTRA LONG HEX KEY (Plastic Holder + Double Blister)

ITEM NO.	SET	SIZE (mm)(inch)	PACKING
0353-12VH	12pcs	0.05, 1/16, 5/64, 3/32, 7/64, 1/8, 9/64, 5/32, 3/16, 7/32, 1/4, 5/16	48/18.4/1.5
0353-M12VH	12pcs	1/16, 5/64, 3/32, 7/64, 1/8, 9/64, 5/32, 3/16, 7/32, 1/4, 5/16, 3/8	36/19.7/1.2
0353-13VH	13pcs	0.05, 1/16, 5/64, 3/32, 7/64, 1/8, 9/64, 5/32, 3/16, 7/32, 1/4, 5/16, 3/8	36/19.7/1.2
353-9V	9pcs	1.5, 2, 2.5, 3, 4, 5, 6, 8, 10	36/17.7/1.6
0353-L0V	10pcs	1.5, 2, 2.5, 3, 4, 5, 6, 8, 10, 12	24/19.0/0.9



⚙️ SHORT ARM BALL POINT (Plastic Holder + Double Blister)

ITEM NO.	SET	SIZE (mm)(inch)	PACKING
3351-12VH	12pcs	0.05, 1/16, 5/64, 3/32, 7/64, 1/8, 9/64, 5/32, 3/16, 7/32, 1/4, 5/16	72/21.9/1.4
3351-M12VH	12pcs	1/16, 5/64, 3/32, 7/64, 1/8, 9/64, 5/32, 3/16, 7/32, 1/4, 5/16, 3/8	48/20.0/1.4
3351-13VH	13pcs	0.05, 1/16, 5/64, 3/32, 7/64, 1/8, 9/64, 5/32, 3/16, 7/32, 1/4, 5/16, 3/8	48/20.0/1.4
351-9V	9pcs	1.5, 2, 2.5, 3, 4, 5, 6, 8, 10	72/21.0/1.3
3351-L0V	10pcs	1.5, 2, 2.5, 3, 4, 5, 6, 8, 10, 12	36/17.5/1.0



⚙️ LONG ARM BALL POINT (Plastic Holder + Double Blister)

ITEM NO.	SET	SIZE (mm)(inch)	PACKING
3352-12VH	12pcs	0.05, 1/16, 5/64, 3/32, 7/64, 1/8, 9/64, 5/32, 3/16, 7/32, 1/4, 5/16	48/15.7/1.3
3352-M12VH	12pcs	1/16, 5/64, 3/32, 7/64, 1/8, 9/64, 5/32, 3/16, 7/32, 1/4, 5/16, 3/8	36/16.5/1.1
3352-13VH	13pcs	0.05, 1/16, 5/64, 3/32, 7/64, 1/8, 9/64, 5/32, 3/16, 7/32, 1/4, 5/16, 3/8	36/16.5/1.1
352-9V	9pcs	1.5, 2, 2.5, 3, 4, 5, 6, 8, 10	48/19.0/1.3
3352-L0V	10pcs	1.5, 2, 2.5, 3, 4, 5, 6, 8, 10, 12	24/16.0/0.8



⚙️ EXTRA LONG BALL POINT (Plastic Holder + Double Blister)

ITEM NO.	SET	SIZE (mm)(inch)	PACKING
3353-12VH	12pcs	0.05, 1/16, 5/64, 3/32, 7/64, 1/8, 9/64, 5/32, 3/16, 7/32, 1/4, 5/16	48/18.4/1.5
3353-M12VH	12pcs	1/16, 5/64, 3/32, 7/64, 1/8, 9/64, 5/32, 3/16, 7/32, 1/4, 5/16, 3/8	36/19.7/1.2
3353-13VH	13pcs	0.05, 1/16, 5/64, 3/32, 7/64, 1/8, 9/64, 5/32, 3/16, 7/32, 1/4, 5/16, 3/8	36/17.7/1.6
353-9V	9pcs	1.5, 2, 2.5, 3, 4, 5, 6, 8, 10	36/17.7/1.2
3353-L0V	10pcs	1.5, 2, 2.5, 3, 4, 5, 6, 8, 10, 12	24/19.0/0.9



WRENCH SET



● SHORT ARM HEX KEY WRENCH SET (Plastic Case)

ITEM NO.	SET	SIZE (mm)(inch)	PACKING
041B-16V	16pcs	1.5, 2, 2.5, 3, 4, 5, 5.5, 6 1/16, 5/64, 3/32, 1/8, 5/32, 3/16, 7/32, 1/4	72/19.7/1.9



● LONG / SHORT ARM HEX KEY WRENCH SET (Plastic Case)

ITEM NO.	SET	SIZE (mm)(inch)	PACKING
041B-30V	30pcs	0.7, 0.9, 1.3, 1.5, 2, 2.5, 3, 4, 4.5, 5, 5.5, 6, 7, 8, 10 0.028, 0.035, 0.05, 1/16, 5/64, 3/32, 7/64, 1/8, 9/64, 5/32, 3/16, 7/32, 1/4, 5/16, 3/8	18/19.0/1.8



● SHORT ARM HEX KEY WRENCH SET (Plastic Case)

ITEM NO.	SET	SIZE (mm)(inch)	PACKING
041B-8V	8pcs	2, 2.5, 3, 4, 5, 6, 8, 10	60/19.0/0.7
041B-9V	9pcs	1.5, 2, 2.5, 3, 4, 5, 6, 8, 10	60/19.0/0.7

PLASTIC CASE WRENCH SET

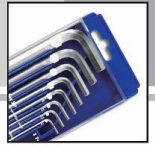

● SHORT ARM HEX KEY SET (Plastic Case)

ITEM NO.	SET	SIZE (mm)	PACKING
041-8V	8pcs	2, 2.5, 3, 4, 5, 6, 8, 10	60/19.0/0.7
041-9V	9pcs	1.5, 2, 2.5, 3, 4, 5, 6, 8, 10	60/19.0/0.7



● EXTRA LONG HEX KEY WRENCH SET (Plastic Case)

ITEM NO.	SET	SIZE (mm)(inch)	PACKING
042-8V	8pcs	2, 2.5, 3, 4, 5, 6, 8, 10	36/20.8/0.8
042-8VH	8pcs	5/64, 3/32, 1/8, 5/32, 3/16, 1/4, 5/16, 3/8	36/20.8/0.8
042-9V	9pcs	1.5, 2, 2.5, 3, 4, 5, 6, 8, 10	36/21.0/0.8



● EXTRA LONG BALL POINT HEX KEY WRENCH SET (Plastic Case)

ITEM NO.	SET	SIZE (mm)(inch)	PACKING
043-8V	8pcs	2, 2.5, 3, 4, 5, 6, 8, 10	36/20.6/0.8
043-8VH	8pcs	5/64, 3/32, 1/8, 5/32, 3/16, 1/4, 5/16, 3/8	36/20.6/0.8
043-9V	9pcs	1.5, 2, 2.5, 3, 4, 5, 6, 8, 10	36/21.0/0.8



WRENCH SET



● HEX KEY WRENCH SET (Metal Case)

ITEM NO.	SET	SIZE (mm)	PACKING
03M-15V	15pcs	Extra long hex key: 3, 4, 5, 6, 8, 10, 12, 14 Folding hex key: 1.5, 2, 2.5, 3, 4, 5, 6	12/21.5/0.6



● EXTRA LONG HEX KEY WRENCH SET (Blow Case)

ITEM NO.	SET	SIZE (mm)	PACKING
03W-10V	10pcs	3, 4, 5, 6, 7, 8, 10, 12, 14, 17	8/20.5/1.2



● EXTRA LONG BALL POINT HEX KEY WRENCH SET (Blow Case)

ITEM NO.	SET	SIZE (mm)	PACKING
33W-10V	10pcs	3, 4, 5, 6, 7, 8, 10, 12, 14, 17	8/20.5/1.2



● **SHORT ARM HEX KEY (Plastic Holder + Slide Card)**

ITEM NO.	SET	SIZE (mm)(inch)	PACKING
061-9V	9pcs	1.5, 2, 2.5, 3, 4, 5, 6, 8, 10	72/23.0/1.45
061-9VH	9pcs	1/16, 5/64, 3/32, 1/8, 5/32, 3/16, 1/4, 5/16, 3/8	72/23.0/1.45
061-0V-7	10pcs	1.5, 2, 2.5, 3, 4, 5, 6, 7, 8, 10	48/17.7/1.1
061-0V	10pcs	1.5, 2, 2.5, 3, 4, 5, 5.5, 6, 8, 10	48/17.3/1.1



● **LONG ARM HEX KEY (Plastic Holder + Slide Card)**

ITEM NO.	SET	SIZE (mm)(inch)	PACKING
062-9V	9pcs	1.5, 2, 2.5, 3, 4, 5, 6, 8, 10	48/19.6/1.4
062-9VH	9pcs	1/16, 5/64, 3/32, 1/8, 5/32, 3/16, 1/4, 5/16, 3/8	48/19.6/1.4
062-0V-7	10pcs	1.5, 2, 2.5, 3, 4, 5, 6, 7, 8, 10	36/17.0/1.2
062-0V	10pcs	1.5, 2, 2.5, 3, 4, 5, 5.5, 6, 8, 10	36/16.2/1.2



● **EXTRA LONG HEX KEY (Plastic Holder + Slide Card)**

ITEM NO.	SET	SIZE (mm)(inch)	PACKING
063-9V	9pcs	1.5, 2, 2.5, 3, 4, 5, 6, 8, 10	36/18.4/1.8
063-9VH	9pcs	1/16, 5/64, 3/32, 1/8, 5/32, 3/16, 1/4, 5/16, 3/8	36/18.4/1.8
063-0V-7	10pcs	1.5, 2, 2.5, 3, 4, 5, 6, 7, 8, 10	36/22.0/1.8
063-0V	10pcs	1.5, 2, 2.5, 3, 4, 5, 5.5, 6, 8, 10	36/20.7/1.8



BALL ON BALL POINT HEX KEY WRENCH SET *Patent*

The joint of the screws and wrench make them workable in the gap.



LONG ARM BALL ON BALL POINT HEX KEY

(Plastic Holder + Slide Card)

ITEM NO.	SET	SIZE (mm)(inch)	PACKING
B362-9V	9pcs	1.5, 2, 2.5, 3, 4, 5, 6, 8, 10	48/19.6/1.4
B362-9VH	9pcs	1/16, 5/64, 3/32, 1/8, 5/32, 3/16, 1/4, 5/16, 3/8	48/19.6/1.4
B362-0V-7	10pcs	1.5, 2, 2.5, 3, 4, 5, 6, 7, 8, 10	36/17.0/1.2
B362-0V	10pcs	1.5, 2, 2.5, 3, 4, 5, 5.5, 6, 8, 10	36/16.2/1.2



EXTRA LONG BALL ON BALL POINT HEX KEY

(Plastic Holder + Slide Card)

ITEM NO.	SET	SIZE (mm)(inch)	PACKING
B363-9V	9pcs	1.5, 2, 2.5, 3, 4, 5, 6, 8, 10	36/19.4/1.8
B363-9VH	9pcs	1/16, 5/64, 3/32, 1/8, 5/32, 3/16, 1/4, 5/16, 3/8	36/19.4/1.8
B363-0V-7	10pcs	1.5, 2, 2.5, 3, 4, 5, 6, 7, 8, 10	36/22.0/1.8
B363-0V	10pcs	1.5, 2, 2.5, 3, 4, 5, 5.5, 6, 8, 10	36/20.7/1.8



EXTRA LONG BALL ON HEX KEY

(Plastic Holder + Slide Card)

ITEM NO.	SET	SIZE (mm)(inch)	PACKING
B063-9V	9pcs	1.5, 2, 2.5, 3, 4, 5, 6, 8, 10	36/18.4/1.8
B063-9VH	9pcs	1/16, 5/64, 3/32, 1/8, 5/32, 3/16, 1/4, 5/16, 3/8	36/18.4/1.8
B063-0V-7	10pcs	1.5, 2, 2.5, 3, 4, 5, 6, 7, 8, 10	36/22.0/1.8
B063-0V	10pcs	1.5, 2, 2.5, 3, 4, 5, 5.5, 6, 8, 10	36/20.7/1.8





●● SHORT ARM BALL POINT HEX KEY

(Plastic Holder + Slide Card)

ITEM NO.	SET	SIZE (mm)(inch)	PACKING
361-9V	9pcs	1.5, 2, 2.5, 3, 4, 5, 6, 8, 10	72/22.0/1.4
361-9VH	9pcs	1/16, 5/64, 3/32, 1/8, 5/32, 3/16, 1/4, 5/16, 3/8	72/22.0/1.4
361-0V-7	10pcs	1.5, 2, 2.5, 3, 4, 5, 6, 7, 8, 10	48/17.7/1.1
361-0V	10pcs	1.5, 2, 2.5, 3, 4, 5, 5.5, 6, 8, 10	48/17.3/1.1



●● LONG ARM BALL POINT HEX KEY

(Plastic Holder + Slide Card)

ITEM NO.	SET	SIZE (mm)(inch)	PACKING
362-9V	9pcs	1.5, 2, 2.5, 3, 4, 5, 6, 8, 10	48/19.6/1.4
362-9VH	9pcs	1/16, 5/64, 3/32, 1/8, 5/32, 3/16, 1/4, 5/16, 3/8	48/19.6/1.4
362-0V-7	10pcs	1.5, 2, 2.5, 3, 4, 5, 6, 7, 8, 10	36/17.0/1.2
362-0V	10pcs	1.5, 2, 2.5, 3, 4, 5, 5.5, 6, 8, 10	36/16.2/1.2



●● EXTRA LONG BALL POINT HEX KEY

(Plastic Holder + Slide Card)

ITEM NO.	SET	SIZE (mm)(inch)	PACKING
363-9V	9pcs	1.5, 2, 2.5, 3, 4, 5, 6, 8, 10	36/19.4/1.8
363-9VH	9pcs	1/16, 5/64, 3/32, 1/8, 5/32, 3/16, 1/4, 5/16, 3/8	36/19.4/1.8
363-0V-7	10pcs	1.5, 2, 2.5, 3, 4, 5, 6, 7, 8, 10	36/22.0/1.8
363-0V	10pcs	1.5, 2, 2.5, 3, 4, 5, 5.5, 6, 8, 10	36/20.7/1.8



STRIPED HEX KEY WRENCH SET

Patent



LONG ARM STRIPED HEX KEY

(Plastic Holder + Slide Card)

ITEM NO.	SET	SIZE (mm)(inch)	PACKING
A062-9V	9pcs	1.5, 2, 2.5, 3, 4, 5, 6, 8, 10	48/19.6/1.4
A062-9VH	9pcs	1/16, 5/64, 3/32, 1/8, 5/32, 3/16, 1/4, 5/16, 3/8	48/19.6/1.4
A062-0V-7	10pcs	1.5, 2, 2.5, 3, 4, 5, 6, 7, 8, 10	36/17.0/1.2
A062-0V	10pcs	1.5, 2, 2.5, 3, 4, 5, 5.5, 6, 8, 10	36/16.2/1.2



EXTRA LONG STRIPED HEX KEY

(Plastic Holder + Slide Card)

ITEM NO.	SET	SIZE (mm)(inch)	PACKING
A063-9V	9pcs	1.5, 2, 2.5, 3, 4, 5, 6, 8, 10	36/19.4/1.8
A063-9VH	9pcs	1/16, 5/64, 3/32, 1/8, 5/32, 3/16, 1/4, 5/16, 3/8	36/19.4/1.8
A063-0V-7	10pcs	1.5, 2, 2.5, 3, 4, 5, 6, 7, 8, 10	36/23.0/1.8
A063-0V	10pcs	1.5, 2, 2.5, 3, 4, 5, 5.5, 6, 8, 10	36/21.7/1.8

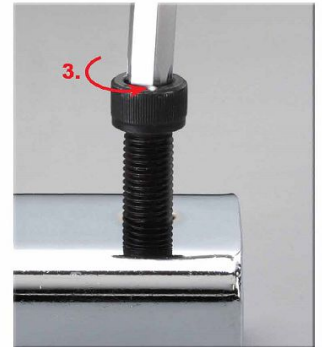

Striped Hex Key Wrench can drive a inner hexagon screws and even can fasten or release a round-off one.



LONG ARM BALL POINT STRIPED HEX KEY

(Plastic Holder + Slide Card)

ITEM NO.	SET	SIZE (mm)(inch)	PACKING
A362-9V	9pcs	1.5, 2, 2.5, 3, 4, 5, 6, 8, 10	48/19.6/1.4
A362-9VH	9pcs	1/16, 5/64, 3/32, 1/8, 5/32, 3/16, 1/4, 5/16, 3/8	48/19.6/1.4
A362-0V-7	10pcs	1.5, 2, 2.5, 3, 4, 5, 6, 7, 8, 10	36/17.0/1.2
A362-0V	10pcs	1.5, 2, 2.5, 3, 4, 5, 5.5, 6, 8, 10	36/16.2/1.2



EXTRA LONG BALL POINT STRIPED HEX KEY

(Plastic Holder + Slide Card)

ITEM NO.	SET	SIZE (mm)(inch)	PACKING
A363-9V	9pcs	1.5, 2, 2.5, 3, 4, 5, 6, 8, 10	36/18.4/1.8
A363-9VH	9pcs	1/16, 5/64, 3/32, 1/8, 5/32, 3/16, 1/4, 5/16, 3/8	36/18.4/1.8
A363-0V-7	10pcs	1.5, 2, 2.5, 3, 4, 5, 6, 7, 8, 10	36/22.0/1.8
A363-0V	10pcs	1.5, 2, 2.5, 3, 4, 5, 5.5, 6, 8, 10	36/20.7/1.8





SHORT ARM STAR KEY (Plastic Holder + Slide Card)

ITEM NO.	SET	SIZE	PACKING
161-9V	9pcs	T10, T15, T20, T25, T27, T30, T40, T45, T50	72/21.5/1.4
161-0V	10pcs	T9, T10, T15, T20, T25, T27, T30, T40, T45, T50	72/21.5/1.4



LONG ARM STAR KEY (Plastic Holder + Slide Card)

ITEM NO.	SET	SIZE	PACKING
162-9V	9pcs	T10, T15, T20, T25, T27, T30, T40, T45, T50	48/18.8/1.4
162-0V	10pcs	T9, T10, T15, T20, T25, T27, T30, T40, T45, T50	48/18.8/1.4



EXTRA LONG ARM STAR KEY (Plastic Holder + Slide Card)

ITEM NO.	SET	SIZE	PACKING
163-9V	9pcs	T10, T15, T20, T25, T27, T30, T40, T45, T50	36/19.3/1.8
163-0V	10pcs	T9, T10, T15, T20, T25, T27, T30, T40, T45, T50	36/19.3/1.8



TAMPER STAR KEY WRENCH SET

Patent



⊛ ⊛ SHORT ARM TAMPER STAR KEY (Plastic Holder + Slide Card)

ITEM NO.	SET	SIZE	PACKING
H161-9V	9pcs	T10, T15, T20, T25, T27, T30, T40, T45, T50	72/21.5/1.4
H161-0V	10pcs	T9, T10, T15, T20, T25, T27, T30, T40, T45, T50	72/21.5/1.4



⊛ ⊛ LONG ARM TAMPER STAR KEY (Plastic Holder + Slide Card)

ITEM NO.	SET	SIZE	PACKING
H162-9V	9pcs	T10, T15, T20, T25, T27, T30, T40, T45, T50	48/18.8/1.4
H162-0V	10pcs	T9, T10, T15, T20, T25, T27, T30, T40, T45, T50	48/18.8/1.4



⊛ ⊛ EXTRA LONG ARM TAMPER STAR KEY (Plastic Holder + Slide Card)

ITEM NO.	SET	SIZE	PACKING
H163-9V	9pcs	T10, T15, T20, T25, T27, T30, T40, T45, T50	36/19.3/1.8
H163-0V	10pcs	T9, T10, T15, T20, T25, T27, T30, T40, T45, T50	36/19.3/1.8

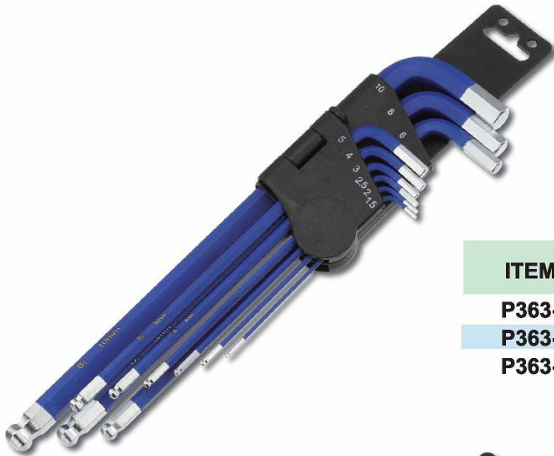

**EXTRA LONG BALL POINT HEX KEY SET
(Plastic Holder + Slide Card)**

ITEM NO.	SET	SIZE (mm)	PACKING
P363-9SC	9pcs	1.5, 2, 2.5, 3, 4, 5, 6, 8, 10	36/18.3/1.8
P363-0SC	10pcs	1.5, 2, 2.5, 3, 4, 5, 5.5, 6, 8, 10	36/19.8/1.8
P363-0S-7	10pcs	1.5, 2, 2.5, 3, 4, 5, 6, 7, 8, 10	36/21.0/1.8

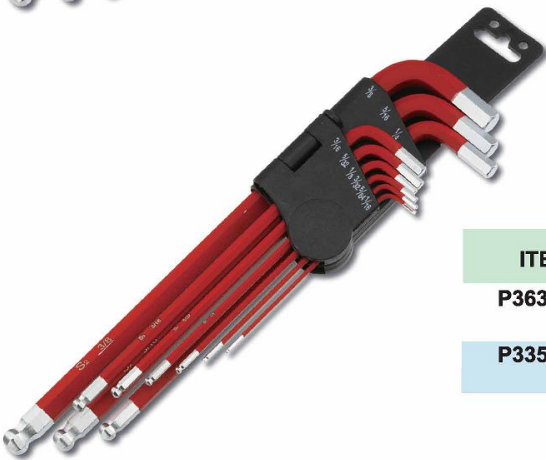

**EXTRA LONG BALL POINT HEX KEY SET
(Plastic Holder + Slide Card)**

ITEM NO.	SET	SIZE (inch)	PACKING
P363-9SHC	9pcs	1/16, 5/64, 3/32, 1/8, 5/32, 3/16, 1/4, 5/16, 3/8	36/18.3/1.8
P3353-13SHC	13pcs	0.05, 1/16, 5/64, 3/32, 7/64, 1/8, 9/64, 5/32, 3/16, 7/32, 1/4, 5/16, 3/8	36/21.8/1.8



**EXTRA LONG STAR KEY SET
(Plastic Holder + Slide Card)**

ITEM NO.	SET	SIZE (mm)(inch)	PACKING
P163-9SC	9pcs	T10, T15, T20, T25, T27, T30, T40, T45, T50	36/18.3/1.8
P1353-13SC	13pcs	T6, T7, T8, T9, T10, T15, T20, T25, T27, T30, T40, T45, T50	36/18.8/1.8

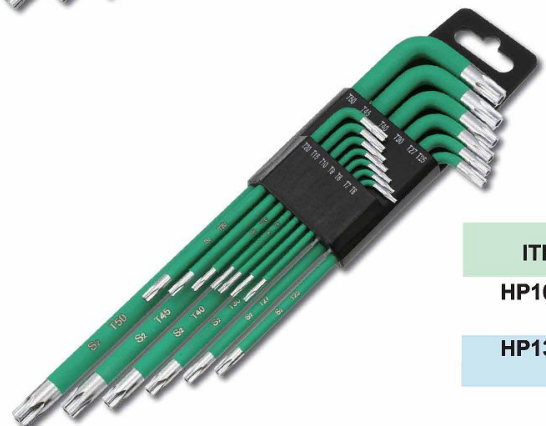

**EXTRA LONG TAMPER STAR KEY SET
(Plastic Holder + Slide Card)**

ITEM NO.	SET	SIZE (mm)(inch)	PACKING
HP163-9SC	9pcs	T10, T15, T20, T25, T27, T30, T40, T45, T50	36/18.3/1.8
HP1353-13SC	13pcs	T6, T7, T8, T9, T10, T15, T20, T25, T27, T30, T40, T45, T50	36/18.8/1.8



TWO FUNCTION KEY WRENCH

Patent

TWO FUNCTION KEY WRENCH BALL POINT HEX & STAR KEY

ITEM NO.	SIZE (long arm short arm)	L (mm)	S (mm)	(g)
313-015	1.5 + T6	90	14	1.5
313-020	2.0 + T8	100	15	3.0
313-025	2.5 + T10	112	18	5.3
313-030	3.0 + T15	126	20	8.3
313-040	4.0 + T20	140	25	18.0
313-050	5.0 + T25	160	28	32.0
313-060	6.0 + T27	180	32	51.0
313-080	8.0 + T30	200	36	102.0
313-100	10.0 + T40	224	40	178.0



EXTRA LONG BALL POINT & STAR KEY WRENCH SET (Plastic Holder + Slide Card)

ITEM NO.	SET	SIZE	PACKING
3183-8	8pcs	2, 2.5, 3, 4, 5, 6, 8, 10 T8, T10, T15, T20, T25, T27, T30, T40	36/19.5/1.8
3183-9	9pcs	1.5, 2, 2.5, 3, 4, 5, 6, 8, 10 T6, T8, T10, T15, T20, T25, T27, T30, T40	36/19.6/1.8



EXTRA LONG BALL POINT HEX KEY & TAMPER STAR KEY WRENCH SET (Plastic Holder + Slide Card)

ITEM NO.	SET	SIZE	PACKING
H3183-8	8pcs	2, 2.5, 3, 4, 5, 6, 8, 10 T8, T10, T15, T20, T25, T27, T30, T40	36/19.5/1.8
H3183-9	9pcs	1.5, 2, 2.5, 3, 4, 5, 6, 8, 10 T6, T8, T10, T15, T20, T25, T27, T30, T40	36/19.6/1.8



●● **SHORT ARM HEX KEY**
(Portable Holder + Color Box)

ITEM NO.	SET	SIZE (mm)(inch)	PACKING
091-18M	18pcs	1.5, 2, 2.5, 3, 3.5, 4, 4.5, 5, 5.5, 6, 7, 8, 9, 10, 12, 14, 17, 19	10/20/21/0.7
091-17H	17pcs	1/16, 5/64, 3/32, 7/64, 1/8, 9/64, 5/32, 3/16, 7/32, 1/4, 5/16, 3/8, 7/16, 1/2, 9/16, 5/8, 3/4	10/20/21/0.7



●● **LONG ARM HEX KEY**
(Portable Holder + Color Box)

ITEM NO.	SET	SIZE (mm)(inch)	PACKING
092-18M	18pcs	1.5, 2, 2.5, 3, 3.5, 4, 4.5, 5, 5.5, 6, 7, 8, 9, 10, 12, 14, 17, 19	6/17/18/0.65
092-17H	17pcs	1/16, 5/64, 3/32, 7/64, 1/8, 9/64, 5/32, 3/16, 7/32, 1/4, 5/16, 3/8, 7/16, 1/2, 9/16, 5/8, 3/4	6/17/18/0.65



●★ **EXTRA LONG ARM HEX KEY & STAR KEY WRENCH SET**
(Portable Holder + Color Box)

ITEM NO.	SET	SIZE (mm)(inch)	PACKING
093-20MH	20pcs	1.5, 2, 2.5, 3, 4, 5, 5.5, 6, 8, 10 1/16, 5/64, 3/32, 1/8, 5/32, 3/16, 7/32, 1/4, 5/16, 3/8	24/20.8/21.8/1.4
1093-20MT	20pcs	1.5, 2, 2.5, 3, 4, 5, 5.5, 6, 8, 10 T9, T10, T15, T20, T25, T27, T30, T40, T45, T50	20/20/21/1.2
1093-20TH	20pcs	T9, T10, T15, T20, T25, T27, T30, T40, T45, T50 1/16, 5/64, 3/32, 1/8, 5/32, 3/16, 7/32, 1/4, 5/16, 3/8	20/20/21/1.2
093-L20MH	20pcs	2, 2.5, 3, 4, 5, 5.5, 6, 8, 10, 12 5/64, 3/32, 1/8, 5/32, 3/16, 7/32, 1/4, 5/16, 3/8, 1/2	12/17.4/18.4/0.8
093-18M	18pcs	1.5, 2, 2.5, 3, 3.5, 4, 4.5, 5, 5.5, 6, 7, 8, 9, 10, 12, 14, 17, 19	6/20/21/0.75
093-17H	17pcs	1/16, 5/64, 3/32, 7/64, 1/8, 9/64, 5/32, 3/16, 7/32, 1/4, 5/16, 3/8, 7/16, 1/2, 9/16, 5/8, 3/4	6/20/21/0.75



●● **EXTRA LONG ARM BALL POINT HEX KEY WRENCH SET**
(Portable Holder + Color Box)

ITEM NO.	SET	SIZE (mm)(inch)	PACKING
3393-20MH	20pcs	1.5, 2, 2.5, 3, 4, 5, 5.5, 6, 8, 10 1/16, 5/64, 3/32, 1/8, 5/32, 3/16, 7/32, 1/4, 5/16, 3/8	24/20.8/21.8/1.4
1393-20MT	20pcs	1.5, 2, 2.5, 3, 4, 5, 5.5, 6, 8, 10 T9, T10, T15, T20, T25, T27, T30, T40, T45, T50	24/20/21/1.2
1393-20HT	20pcs	1/16, 5/64, 3/32, 1/8, 5/32, 3/16, 7/32, 1/4, 5/16, 3/8 T9, T10, T15, T20, T25, T27, T30, T40, T45, T50	24/20/21/1.2



STAR KEY WRENCH SET



SHORT ARM STAR KEY WRENCH SET

(Plastic Folder + Slide Card)

ITEM NO.	SET	SIZE	PACKING
101-S7	7pcs	T6, T7, T8, T9, T10, T15, T20	144/7.8/0.8
101-7	7pcs	T10, T15, T20, T25, T27, T30, T40	144/19.7/1.43
101-6	6pcs	T25, T30, T40, T45, T50, T55	48/17.0/0.8
101-9	9pcs	T10, T15, T20, T25, T27, T30, T40, T45, T50	72/19.0/1.5



LONG ARM STAR KEY WRENCH SET

(Plastic Folder + Slide Card)

ITEM NO.	SET	SIZE	PACKING
102-S7	7pcs	T6, T7, T8, T9, T10, T15, T20	144/13/1.5
102-7	7pcs	T10, T15, T20, T25, T27, T30, T40	72/13.8/0.8
102-9	9pcs	T10, T15, T20, T25, T27, T30, T40, T45, T50	48/17.3/0.8



EXTRA LONG STAR KEY WRENCH SET

(Plastic Folder + Slide Card)

ITEM NO.	SET	SIZE	PACKING
103-7	7pcs	T10, T15, T20, T25, T27, T30, T40	72/16.6/1.2
103-9	9pcs	T10, T15, T20, T25, T27, T30, T40, T45, T50	36/17.0/0.8

TAMPER STAR KEY WRENCH SET



SHORT ARM TAMPER STAR KEY WRENCH SET (Plastic Folder + Slide Card)

ITEM NO.	SET	SIZE	PACKING
H101-S7	7pcs	T6, T7, T8, T9, T10, T15, T20	144/7.8/0.8
H101-7	7pcs	T10, T15, T20, T25, T27, T30, T40	144/19.7/1.43
H101-6	6pcs	T25, T30, T40, T45, T50, T55	48/17.0/0.8
H101-9	9pcs	T10, T15, T20, T25, T27, T30, T40, T45, T50	72/19.0/1.5



LONG ARM TAMPER STAR KEY WRENCH SET (Plastic Folder + Slide Card)

ITEM NO.	SET	SIZE	PACKING
H102-S7	7pcs	T6, T7, T8, T9, T10, T15, T20	144/13/1.5
H102-7	7pcs	T10, T15, T20, T25, T27, T30, T40	72/13.8/0.8
H102-9	9pcs	T10, T15, T20, T25, T27, T30, T40, T45, T50	48/17.3/0.8



EXTRA LONG TAMPER STAR KEY WRENCH SET (Plastic Folder + Slide Card)

ITEM NO.	SET	SIZE	PACKING
H103-7	7pcs	T10, T15, T20, T25, T27, T30, T40	72/16.6/1.2
H103-9	9pcs	T10, T15, T20, T25, T27, T30, T40, T45, T50	36/17.0/0.8



STAR KEY & TAMPER STAR KEY WRENCH



SHORT ARM STAR KEY WRENCH SET (Pouch Bag)

ITEM NO.	SET	SIZE	PACKING
152-S6S	6pcs	T6, T7, T8, T9, T10, T15	360/17.5/0.8
152-S8S	8pcs	T5, T6, T7, T8, T10, T15, T20, T25	360/17.7/0.8
152-8S	8pcs	T6, T7, T8, T9, T10, T15, T20, T25	360/17.7/0.8
152-L7S	7pcs	T27, T30, T40, T45, T50, T55, T60	40/21/0.52



SHORT ARM TAMPER STAR KEY WRENCH SET (Pouch Bag)

ITEM NO.	SET	SIZE	PACKING
H152-S6S	6pcs	T6, T7, T8, T9, T10, T15	360/17.5/0.8
H152-S8S	8pcs	T5, T6, T7, T8, T10, T15, T20, T25	360/17.7/0.8
H152-L7S	7pcs	T27, T30, T40, T45, T50, T55, T60	40/21/0.52



STAR KEY WRENCH SET (Metal Box + Slide Card)

ITEM NO.	SET	SIZE	PACKING
141M-6V	6pcs	T25, T30, T40, T45, T50, T55	36/19.9/1.0



TAMPER STAR KEY WRENCH SET (Metal Box + Slide Card)

ITEM NO.	SET	SIZE	PACKING
H141M-6V	6pcs	T25, T30, T40, T45, T50, T55	36/19.9/1.0

STAR KEY & TAMPER STAR KEY WRENCH



SHORT ARM STAR KEY WRENCH SET (Plastic Case)

ITEM NO.	SET	SIZE	PACKING
141-9	9pcs	T9, T10, T15, T20, T25, T27, T30, T40, T45	60/14.6/0.7
141-L9	9pcs	T10, T15, T20, T25, T27, T30, T40, T45, T50	60/18.2/0.7



SHORT ARM STAR KEY WRENCH SET (Plastic Case)

ITEM NO.	SET	SIZE	PACKING
141B-9	9pcs	T9, T10, T15, T20, T25, T27, T30, T40, T45	60/14.6/0.7
141B-L9	9pcs	T10, T15, T20, T25, T27, T30, T40, T45, T50	60/18.2/0.7



SHORT ARM TAMPER STAR KEY WRENCH SET (Plastic Case)

ITEM NO.	SET	SIZE	PACKING
H141-9	9pcs	T9, T10, T15, T20, T25, T27, T30, T40, T45	60/14.6/0.7
H141-L9	9pcs	T10, T15, T20, T25, T27, T30, T40, T45, T50	60/18.2/0.7



SHORT ARM TAMPER STAR KEY WRENCH SET (Plastic Case)

ITEM NO.	SET	SIZE	PACKING
H141B-9	9pcs	T9, T10, T15, T20, T25, T27, T30, T40, T45	60/14.6/0.7
H141B-L9	9pcs	T10, T15, T20, T25, T27, T30, T40, T45, T50	60/18.2/0.7

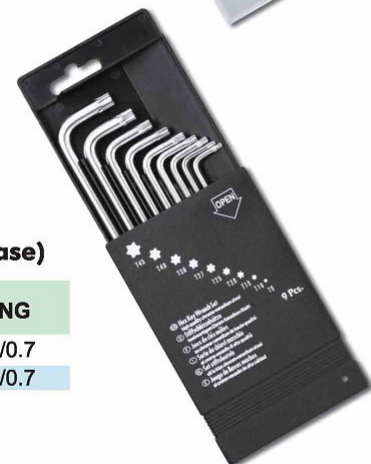



HEX KEY WRENCH SET

Patent



It can be used as T-handle by putting one of the wrenches into the holder



SHORT ARM HEX KEY WRENCH SET

(Plastic Handle + Slide Card)

ITEM NO.	SET	SIZE (mm)(inch)	PACKING
071-8V	8pcs	2, 2.5, 3, 4, 5, 6, 8, 10	60/18/19/1.3
071-8VH	8pcs	5/64, 3/32, 1/8, 5/32, 3/16, 1/4, 5/16, 3/8	60/18/19/1.3



LONG ARM HEX KEY WRENCH SET

(Plastic Handle + Slide Card)

ITEM NO.	SET	SIZE (mm)(inch)	PACKING
072-8V	8pcs	2, 2.5, 3, 4, 5, 6, 8, 10	48/18.3/19.2/1.3
072-8VH	8pcs	5/64, 3/32, 1/8, 5/32, 3/16, 1/4, 5/16, 3/8	48/18.3/19.2/1.3



EXTRA LONG ARM HEX KEY WRENCH SET

(Plastic Handle + Slide Card)

ITEM NO.	SET	SIZE (mm)(inch)	PACKING
073-8V	8pcs	2, 2.5, 3, 4, 5, 6, 8, 10	36/17/18/1.2
073-8VH	8pcs	5/64, 3/32, 1/8, 5/32, 3/16, 1/4, 5/16, 3/8	36/17/18/1.2



SHORT ARM BALL POINT WRENCH SET (Plastic Handle + Slide Card)

It can be used as T-handle by putting one of the wrenches into the holder



ITEM NO.	SET	SIZE (mm)(inch)	PACKING
371-8V	8pcs	2, 2.5, 3, 4, 5, 6, 8, 10	60/17.7/18.7/1.3
371-8VH	8pcs	5/64, 3/32, 1/8, 5/32, 3/16, 1/4, 5/16, 3/8	60/17.7/18.7/1.3



LONG ARM BALL POINT WRENCH SET (Plastic Handle + Slide Card)

ITEM NO.	SET	SIZE (mm)(inch)	PACKING
372-8V	8pcs	2, 2.5, 3, 4, 5, 6, 8, 10	48/18/18.9/1.3
372-8VH	8pcs	5/64, 3/32, 1/8, 5/32, 3/16, 1/4, 5/16, 3/8	48/18/18.9/1.3



EXTRA LONG BALL POINT WRENCH SET (Plastic Handle + Slide Card)

ITEM NO.	SET	SIZE (mm)(inch)	PACKING
373-8V	8pcs	2, 2.5, 3, 4, 5, 6, 8, 10	36/16.9/17.8/1.2
373-8VH	8pcs	5/64, 3/32, 1/8, 5/32, 3/16, 1/4, 5/16, 3/8	36/16.9/17.8/1.2



STAR KEY WRENCH SET

Patent



It can be used as T-handle by putting one of the wrenches into the holder



SHORT ARM STAR KEY WRENCH SET (Plastic Handle + Slide Card)

ITEM NO.	SET	SIZE	PACKING
171-8V	8pcs	T10, T15, T20, T25, T30, T40, T45, T50	60/15.6/16.6/1.3
171-7V	7pcs	T10, T15, T20, T25, T27, T30, T40	60/14.0/15.0/1.3



LONG ARM STAR KEY WRENCH SET (Plastic Handle + Slide Card)

ITEM NO.	SET	SIZE	PACKING
172-8V	8pcs	T10, T15, T20, T25, T30, T40, T45, T50	48/16.3/17.2/1.3
172-7V	7pcs	T10, T15, T20, T25, T27, T30, T40	48/14.8/15.8/1.3



EXTRA LONG STAR KEY WRENCH SET (Plastic Handle + Slide Card)

ITEM NO.	SET	SIZE	PACKING
173-8V	8pcs	T10, T15, T20, T25, T30, T40, T45, T50	36/16.0/17.0/1.2
173-7V	7pcs	T10, T15, T20, T25, T27, T30, T40	36/14.6/15.6/1.2



It can be used as T-handle by putting one of the wrenches into the holder



SHORT ARM TAMPER STAR KEY WRENCH SET
(Plastic Handle + Slide Card)

ITEM NO.	SET	SIZE	PACKING
H171-8V	8pcs	T10, T15, T20, T25, T30, T40, T45, T50	60/15.6/16.6/1.3
H171-7V	7pcs	T10, T15, T20, T25, T27, T30, T40	60/14.0/15.0/1.3



LONG ARM TAMPER STAR KEY WRENCH SET
(Plastic Handle + Slide Card)

ITEM NO.	SET	SIZE	PACKING
H172-8V	8pcs	T10, T15, T20, T25, T30, T40, T45, T50	48/16.3/17.2/1.3
H172-7V	7pcs	T10, T15, T20, T25, T27, T30, T40	48/14.8/15.8/1.3



EXTRA LONG TAMPER STAR KEY WRENCH SET
(Plastic Handle + Slide Card)

ITEM NO.	SET	SIZE	PACKING
H173-8V	8pcs	T10, T15, T20, T25, T30, T40, T45, T50	36/16.0/17.0/1.2
H173-7V	7pcs	T10, T15, T20, T25, T27, T30, T40	36/14.6/15.6/1.2



FOLDING TYPE WRENCH SET



FOLDING TYPE HEX KEY (Slide Card)

ITEM NO.	SET	SIZE (mm)(inch)	PACKING
013-7V	7pcs	2.5, 3, 4, 5, 6, 8, 10	72/26.0/1.0
012-6V	6pcs	2.5, 3, 4, 5, 6, 8	72/20.0/1.0
011-7V	7pcs	1.5, 2, 2.5, 3, 4, 5, 6	120/17.8/1.0
011-6V	6pcs	3, 4, 5, 6, SCREW DRIVER	120/16.0/1.0
014-7VH	7pcs	0.05, 1/16, 5/64, 3/32, 1/8, 5/32, 3/16	120/17.0/1.0
013-8VH	8pcs	5/64, 3/32, 1/8, 5/32, 3/16, 1/4, 5/16, 3/8	72/26.0/1.0
011-7V	7pcs	2, 2.5, 3, 4, 5, SCREW DRIVER	120/16.0/1.0
011-7VH	7pcs	1/16, 5/64, 3/32, 1/8, 5/32, 7/32, 3/16	120/17.0/1.0
011-9VH	9pcs	5/64, 3/32, 7/64, 1/8, 9/64, 5/32, 3/16, 7/32, 1/4	120/18.0/1.0
013-8V	8pcs	2, 2.5, 3, 4, 5, 6, 8, 10	72/26.7/1.0
012-6VH	6pcs	3/32, 1/8, 5/32, 3/16, 1/4, 5/16	72/20.0/1.0



FOLDING TYPE STAR KEY WRENCH SET (Slide Card)

ITEM NO.	SET	SIZE	PACKING
113-8V	8pcs	T9, T10, T15, T20, T25, T27, T30, T40	72/17.0/1.2



FOLDING TYPE TAMPER STAR KEY WRENCH SET (Slide Card)

ITEM NO.	SET	SIZE	PACKING
H113-8V	8pcs	T9, T10, T15, T20, T25, T27, T30, T40	72/17.0/1.2

FOLDING TYPE WRENCH SET



PLASTIC FOLDING TYPE HEX KEY (Slide Card)

ITEM NO.	SET	SIZE (mm)(inch)	PACKING
P011-7VH	7pcs	1/16, 5/64, 3/32, 1/8, 5/32, 3/16, 1/4	72/11.0/1.3
P011-7V	7pcs	1.5, 2, 2.5, 3, 4, 5, 6	72/11.0/1.3
P012-9VH	9pcs	0.05, 1/16, 5/64, 3/32, 7/64, 1/8, 9/64, 5/32, 3/16	72/11.0/1.3
P012-7V	7pcs	1.27, 1.5, 2, 2.5, 3, 4, 5	72/10.0/1.3
P012-11VH	11pcs	0.05, 1/16, 5/64, 3/32, 7/64, 1/8, 9/64, 5/32, 3/16, 7/32, 1/4	72/12.0/1.3
P012-11V	11pcs	1.27, 1.5, 2, 2.5, 3, 3.5, 4, 4.5, 5, 5.5, 6	72/12.0/1.3
P012-8VH	8pcs	1/16, 5/64, 3/32, 1/8, 5/32, 3/16, 7/32, 1/4	72/11.5/1.3



FOLDING TYPE BICYCLE TOOLS (Slide Card)

ITEM NO.	SET	SIZE (mm)	PACKING
P016-6V	6pcs	3, 4, 5, 6, \ominus \oplus SCREW DRIVER	72/11.8/1.3
P016-8V	8pcs	2, 2.5, 3, 4, 5, 6, \ominus \oplus SCREW DRIVER	72/12.0/1.3



FOLDING TYPE BICYCLE TOOLS (Slide Card)

ITEM NO.	SET	SIZE (mm)	PACKING
P018-0V	10pcs	2, 2.5, 3, 4, 5, 6, \ominus \oplus SCREW DRIVER, MULTIFUNCTION, SPANNER	72/16.5/1.5



FOLDING TYPE BICYCLE TOOLS (Slide Card)

ITEM NO.	SET	SIZE (mm)	PACKING
P019-11V	11pcs	2, 2.5, 3, 4, 5, 6, \ominus \oplus SCREW DRIVER, MULTIFUNCTION, SPANNER, CHAIN RIVET, EXTRACTOR	72/18.0/1.5





FOLDING TYPE WRENCH SET

Patent



LONG ARM PLASTIC FOLDING TYPE HEX KEY SET

(Slide On Card)

ITEM NO.	SET	SIZE (mm)(inch)	PACKING
PL011-7V	7pcs	1.5, 2, 2.5, 3, 4, 5, 6	72/14.5/1.2
PL012-6V	6pcs	2.5, 3, 4, 5, 6, 8	72/17.8/1.2
PL013-7V	7pcs	2.5, 3, 4, 5, 6, 8, 10	48/18.3/0.9
PL011-7VH	7pcs	1/16, 5/64, 3/32, 1/8, 5/32, 3/16, 1/4	72/14.5/1.2
PL013-7VH	7pcs	3/32, 1/8, 5/32, 3/16, 1/4, 5/16, 3/8	48/18.3/0.9



LONG ARM PLASTIC FOLDING TYPE BALL POINT HEX KEY SET

(Slide On Card)

ITEM NO.	SET	SIZE (mm)(inch)	PACKING
PL311-7V	7pcs	1.5, 2, 2.5, 3, 4, 5, 6	72/14.5/1.2
PL312-6V	6pcs	2.5, 3, 4, 5, 6, 8	72/17.8/1.2
PL313-7V	7pcs	2.5, 3, 4, 5, 6, 8, 10	48/18.3/0.9
PL311-7VH	7pcs	1/16, 5/64, 3/32, 1/8, 5/32, 3/16, 1/4	72/14.5/1.2
PL313-7VH	7pcs	3/32, 1/8, 5/32, 3/16, 1/4, 5/16, 3/8	48/18.3/0.9



LONG ARM PLASTIC FOLDING TYPE STAR KEY SET

(Slide On Card)

ITEM NO.	SET	SIZE	PACKING
PL101-7V	7pcs	T10, T15, T20, T25, T27, T30, T40	72/15.6/16.6/1.2
PL101-8V	8pcs	T9, T10, T15, T20, T25, T27, T30, T40	72/15.9/16.9/1.2



LONG ARM PLASTIC FOLDING TYPE TAMPER STAR KEY SET

(Slide On Card)

ITEM NO.	SET	SIZE	PACKING
HPL101-7V	7pcs	T10, T15, T20, T25, T27, T30, T40	72/15.6/16.6/1.2
HPL101-8V	8pcs	T9, T10, T15, T20, T25, T27, T30, T40	72/15.9/16.9/1.2

FOLDING TYPE WRENCH SET



PLASTIC FOLDING TYPE STAR KEY WRENCH SET

(Slide Card)

ITEM NO.	SET	SIZE	PACKING
PB101-7V	7pcs	T10, T15, T20, T25, T27, T30, T40	100/20.5/0.9
PB101-8V	8pcs	T9, T10, T15, T20, T25, T27, T30, T40	100/21.0/0.9
PB120-8V	8pcs	T5, T6, T7, T8, T9, T10, T15, T20	100/13.4/0.9
PB101-6V	6pcs	T10, T15, T20, T25, T27, T30	100/16.6/0.9
PB121-8V	8pcs	T6, T7, T8, T9, T10, T15, T20, T25	100/14.3/0.9



PLASTIC FOLDING TAMPER STAR KEY WRENCH SET

(Slide Card)

ITEM NO.	SET	SIZE	PACKING
HPB101-7V	7pcs	T10, T15, T20, T25, T27, T30, T40	100/20.5/0.9
HPB101-8V	8pcs	T9, T10, T15, T20, T25, T27, T30, T40	100/21.0/0.9
HPB120-8V	8pcs	T5, T6, T7, T8, T9, T10, T15, T20	100/13.4/0.9
HPB101-6V	6pcs	T10, T15, T20, T25, T27, T30	100/16.6/0.9
HPB121-8V	8pcs	T6, T7, T8, T9, T10, T15, T20, T25	100/14.3/0.9



PLASTIC FOLDING HEX KEY WRENCH SET

(Slide Card)

ITEM NO.	SET	SIZE (mm)(inch)	PACKING
PB011-7V	7pcs	1.5, 2, 2.5, 3, 4, 5, 6	100/14.9/0.9
PB011-9V	9pcs	1.5, 2, 2.5, 3, 3.5, 4, 5, 5.5, 6	100/17.7/0.9
PB012-6V	6pcs	2.5, 3, 4, 5, 6, 8	100/18.5/0.9
PB011-9VH	9pcs	1/16, 5/64, 3/32, 7/64, 1/8, 5/32, 3/16, 7/32, 1/4	100/17.5/0.9
PB012-6VH	6pcs	3/32, 1/8, 5/32, 3/16, 1/4, 5/16	100/18.5/0.9



FOLDING TYPE WRENCH SET

Patent



FOLDING TYPE BALL POINT HEX KEY WRENCH SET

(Slide On Card)

ITEM NO.	SET	SIZE (mm)(inch)	PACKING
2P311-7V	7pcs	1.5, 2, 2.5, 3, 4, 5, 6	96/15.8/16.8/1.53
2P311-7VH	7pcs	1/16, 5/64, 3/32, 1/8, 5/32, 3/16, 1/4	96/15.8/16.8/1.53
2P312-6V	6pcs	2.5, 3, 4, 5, 6, 8	72/14.0/15.0/1.14
2P312-6VH	6pcs	3/32, 1/8, 5/32, 3/16, 1/4, 5/16	72/14.0/15.0/1.14
2P313-7V	7pcs	2.5, 3, 4, 5, 6, 8, 10	72/19.3/20.3/1.14
2P313-7VH	7pcs	3/32, 1/8, 5/32, 3/16, 1/4, 5/16, 3/8	72/19.3/20.3/1.14
2P316-7V	7pcs	2.5, 3, 4, 5, 6, SCREW DRIVER	96/19.2/20.2/1.53



FOLDING TYPE HEX KEY WRENCH SET

(Slide On Card)

ITEM NO.	SET	SIZE (mm)(inch)	PACKING
2P011-7V	7pcs	1.5, 2, 2.5, 3, 4, 5, 6	96/15.8/16.8/1.53
2P011-7VH	7pcs	1/16, 5/64, 3/32, 1/8, 5/32, 3/16, 1/4	96/15.8/16.8/1.53
2P012-6V	6pcs	2.5, 3, 4, 5, 6, 8	72/14.0/15.0/1.14
2P012-6VH	6pcs	3/32, 1/8, 5/32, 3/16, 1/4, 5/16	72/14.0/15.0/1.14
2P013-7V	7pcs	2.5, 3, 4, 5, 6, 8, 10	72/19.3/20.3/1.14
2P013-7VH	7pcs	3/32, 1/8, 5/32, 3/16, 1/4, 5/16, 3/8	72/19.3/20.3/1.14
2P016-7V	7pcs	2.5, 3, 4, 5, 6, SCREW DRIVER	96/19.2/20.2/1.53



FOLDING TYPE STAR KEY WRENCH SET (Slide On Card)

ITEM NO.	SET	SIZE	PACKING
2P101-7V	7pcs	T10, T15, T20, T25, T27, T30, T40	96/18.5/19.5/1.53
2P101-8V	8pcs	T9, T10, T15, T20, T25, T27, T30, T40	96/18.9/19.9/1.53
2P120-8V	8pcs	T5, T6, T7, T8, T9, T10, T15, T20	96/17.0/18.0/1.53
2P121-8V	8pcs	T6, T7, T8, T9, T10, T15, T20, T25	96/17.5/18.5/1.53
2P122-0V	10pcs	T6, T7, T8, T9, T10, T15, T20, T25, T27, T30	96/19.5/20.5/1.53



FOLDING TYPE TAMPER STAR KEY WRENCH SET

(Slide On Card)

ITEM NO.	SET	SIZE	PACKING
H2P101-7V	7pcs	T10, T15, T20, T25, T27, T30, T40	96/18.5/19.5/1.53
H2P101-8V	8pcs	T9, T10, T15, T20, T25, T27, T30, T40	96/18.9/19.9/1.53
H2P120-8V	8pcs	T5, T6, T7, T8, T9, T10, T15, T20	96/17.0/18.0/1.53
H2P121-8V	8pcs	T6, T7, T8, T9, T10, T15, T20, T25	96/17.5/18.5/1.53
H2P122-0V	10pcs	T6, T7, T8, T9, T10, T15, T20, T25, T27, T30	96/19.5/20.5/1.53



ALUMINUM FOLDING TYPE WRENCH SET



7 PCS ALUMINUM FOLDING TYPE HEX & SCREW DRIVER

(Slide Card)

ITEM NO.	SET	SIZE(mm)	PACKING
SAL016-7VM	7pcs	HEX: 2.5, 3, 4, 5, 6, ⊖ ⊕ SCREW DRIVER	96/13.5/14.5/0.6



7 PCS ALUMINUM FOLDING TYPE HEX KEY WRENCH SET

(Slide Card)

ITEM NO.	SET	SIZE(mm)	PACKING
SAL011-7VM	7pcs	1.5, 2, 2.5, 3, 4, 5, 6	96/11.7/12.7/0.6



7 PCS ALUMINUM FOLDING TYPE BALL POINT WRENCH SET

(Slide Card)

ITEM NO.	SET	SIZE (mm)(inch)	PACKING
SAL311-7VM	7pcs	1.5, 2, 2.5, 3, 4, 5, 6	96/11.7/12.7/0.6
SAL311-8VHM	8pcs	1/16, 5/64, 3/32, 1/8, 5/32, 3/16, 7/32, 1/4	96/14.5/0.6



7 PCS ALUMINUM FOLDING TYPE STAR KEY WRENCH SET

(Slide Card)

ITEM NO.	SET	SIZE	PACKING
SAL101-7SM	7pcs	T6, T7, T8, T9, T10, T15, T20	96/9.8/10.8/0.6



7 PCS ALUMINUM FOLDING TYPE TAMPER STAR KEY SET

(Slide Card)

ITEM NO.	SET	SIZE	PACKING
HSAL101-7SM	7pcs	T6, T7, T8, T9, T10, T15, T20	96/9.8/10.8/0.6



LOW-PROFILE HEX KEY

LONG ARM HEX KEY

ITEM NO.	SIZE (mm)	L (mm)	S (mm)	(g)
S02-015	1.5	77	4	1.4
S02-020	2.0	83	5	2.5
S02-025	2.5	90	5	4.0
S02-030	3.0	96	6	6.3
S02-040	4.0	105	8	14.0
S02-050	5.0	115	10	22.0
S02-055	5.5	124	10	28.0
S02-060	6.0	133	10	35.0
S02-070	7.0	141	12	51.0
S02-080	8.0	154	12	72.0
S02-090	9.0	156	16	95.0
S02-100	10.0	170	16	128.0

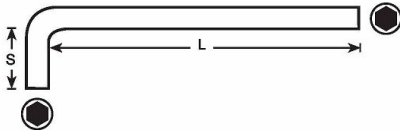

ITEM NO.	SIZE (inch)	L (mm)	S (mm)	(g)
S02-0.05	0.05	72	4	1.0
S02-1/16	1/16	77	4	1.4
S02-5/64	5/64	83	5	2.5
S02-3/32	3/32	90	5	4.0
S02-7/64	7/64	94	6	6.0
S02-1/8	1/8	96	6	7.0
S02-9/64	9/64	102	7	11.0
S02-5/32	5/32	105	8	14.0
S02-3/16	3/16	115	9	21.0
S02-7/32	7/32	124	10	28.0
S02-1/4	1/4	133	10	40.0
S02-5/16	5/16	154	12	72.0
S02-3/8	3/8	170	16	117.0



LONG ARM HEX KEY SET (Plastic Holder+Slide Card)

ITEM NO.	SET	SIZE (mm)(inch)	PACKING
S0352-13S	13pcs	0.05, 1/16, 5/64, 3/32, 7/64, 1/8, 9/64, 5/32, 3/16, 7/32, 1/4, 5/16, 3/8	48/20.2/1.3
S0352-9S	9pcs	1.5, 2, 2.5, 3, 4, 5, 6, 8, 10	48/17.7/1.3

LOW-PROFILE HEX KEY



EXTRA LONG HEX KEY

ITEM NO.	SIZE (mm)	L (mm)	S (mm)	(g)
S03-015	1.5	90	4	1.5
S03-020	2.0	100	4	3.0
S03-025	2.5	112	5	5.0
S03-030	3.0	126	6	8.0
S03-040	4.0	142	8	17.0
S03-050	5.0	160	10	30.0
S03-055	5.5	170	10	38.0
S03-060	6.0	180	10	48.0
S03-070	7.0	190	12	70.0
S03-080	8.0	200	12	95.0
S03-090	9.0	210	16	127.0
S03-100	10.0	224	16	165.0

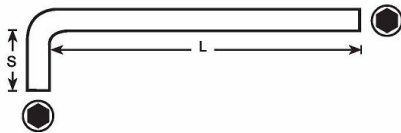

ITEM NO.	SIZE (inch)	L (mm)	S (mm)	(g)
S03-0.05	0.05	80	4	1.0
S03-1/16	1/16	90	4	1.6
S03-5/64	5/64	100	5	3.0
S03-3/32	3/32	112	5	5.0
S03-7/64	7/64	118	6	7.0
S03-1/8	1/8	126	6	9.0
S03-9/64	9/64	134	8	13.0
S03-5/32	5/32	142	8	17.0
S03-3/16	3/16	160	10	27.0
S03-7/32	7/32	170	10	38.0
S03-1/4	1/4	180	10	53.0
S03-5/16	5/16	200	12	95.0
S03-3/8	3/8	224	16	150.0



EXTRA LONG HEX KEY SET (Plastic Holder+Slide Card)

ITEM NO.	SET	SIZE (mm)(inch)	PACKING
S0353-13S	13pcs	0.05, 1/16, 5/64, 3/32, 7/64, 1/8, 9/64, 5/32, 3/16, 7/32, 1/4, 5/16, 3/8	36/18.8/1.6
S0353-9S	9pcs	1.5, 2, 2.5, 3, 4, 5, 6, 8, 10	36/17.0/1.2



LOW-PROFILE BALL POINT

LONG ARM BALL POINT HEX KEY

ITEM NO.	SIZE (mm)	L (mm)	S (mm)	(g)
S31-015	1.5	77	4	1.4
S31-020	2.0	83	5	2.5
S31-025	2.5	90	5	4.0
S31-030	3.0	96	6	6.3
S31-040	4.0	105	8	14.0
S31-050	5.0	115	10	22.0
S31-055	5.5	124	10	28.0
S31-060	6.0	133	10	35.0
S31-070	7.0	141	12	51.0
S31-080	8.0	154	12	72.0
S31-090	9.0	156	16	95.0
S31-100	10.0	170	16	128.0

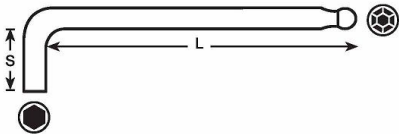

ITEM NO.	SIZE (inch)	L (mm)	S (mm)	(g)
S31-0.05	0.05	72	4	1.0
S31-1/16	1/16	77	4	1.4
S31-5/64	5/64	83	5	2.5
S31-3/32	3/32	90	5	4.0
S31-7/64	7/64	94	6	6.0
S31-1/8	1/8	96	6	7.0
S31-9/64	9/64	102	7	11.0
S31-5/32	5/32	105	8	14.0
S31-3/16	3/16	115	9	21.0
S31-7/32	7/32	124	10	28.0
S31-1/4	1/4	133	10	40.0
S31-5/16	5/16	154	12	72.0
S31-3/8	3/8	170	16	117.0



LONG ARM BALL POINT HEX KEY SET (Plastic Holder+Slide Card)

ITEM NO.	SET	SIZE (mm)(inch)	PACKING
S3352-13S	13pcs	0.05, 1/16, 5/64, 3/32, 7/64, 1/8, 9/64, 5/32, 3/16, 7/32, 1/4, 5/16, 3/8	48/20.2/1.3
S3352-9S	9pcs	1.5, 2, 2.5, 3, 4, 5, 6, 8, 10	48/17.7/1.3

LOW-PROFILE BALL POINT

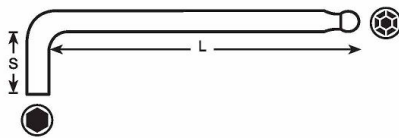

EXTRA LONG BALL POINT HEX KEY

ITEM NO.	SIZE (mm)	L (mm)	S (mm)	⚖️ (g)
S33-015	1.5	90	4	1.5
S33-020	2.0	100	4	3.0
S33-025	2.5	112	5	5.0
S33-030	3.0	126	6	8.0
S33-040	4.0	142	8	17.0
S33-050	5.0	160	10	30.0
S33-055	5.5	170	10	38.0
S33-060	6.0	180	10	48.0
S33-070	7.0	190	12	70.0
S33-080	8.0	200	12	95.0
S33-090	9.0	210	16	127.0
S33-100	10.0	224	16	165.0

ITEM NO.	SIZE (inch)	L (mm)	S (mm)	⚖️ (g)
S33-0.05	0.05	80	4	1.0
S33-1/16	1/16	90	4	1.6
S33-5/64	5/64	100	5	3.0
S33-3/32	3/32	112	5	5.0
S33-7/64	7/64	118	6	7.0
S33-1/8	1/8	126	6	9.0
S33-9/64	9/64	134	8	13.0
S33-5/32	5/32	142	8	17.0
S33-3/16	3/16	160	10	27.0
S33-7/32	7/32	170	10	38.0
S33-1/4	1/4	180	10	53.0
S33-5/16	5/16	200	12	95.0
S33-3/8	3/8	224	16	150.0



EXTRA LONG BALL POINT HEX KEY SET (Plastic Holder+Slide Card)

ITEM NO.	SET	SIZE (mm)(inch)	PACKING
S3353-13S	13pcs	0.05, 1/16, 5/64, 3/32, 7/64, 1/8, 9/64, 5/32, 3/16, 7/32, 1/4, 5/16, 3/8	36/18.8/1.6
S3353-9S	9pcs	1.5, 2, 2.5, 3, 4, 5, 6, 8, 10	36/17.0/1.2



POWER HANDLE WRENCH

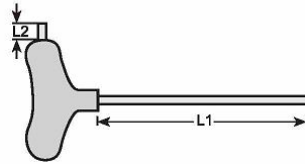

METRIC POWER HANDLE HEX KEY WRENCH

ITEM NO.	SIZE (mm)	L1 (mm)	L2 (mm)	⚖️ (g)	PACKING
2PH03-0127	1.27	100	18	30.0	6/72/2.3/3.3/0.98
2PH03-015	1.5	100	18	30.0	6/72/2.5/3.5/0.98
2PH03-020	2.0	100	18	30.0	6/72/2.5/3.5/0.98
2PH03-025	2.5	100	18	33.0	6/72/3.0/4.0/0.98
2PH03-030	3.0	100	18	36.0	6/72/3.3/4.3/0.98
2PH03-040	4.0	150	20	70.0	6/72/5.3/6.3/1.48
2PH03-050	5.0	150	20	85.0	6/72/6.7/7.7/1.48
2PH03-055	5.5	150	20	94.0	6/72/7.3/8.3/1.48
2PH03-060	6.0	150	20	102.0	6/72/8.0/9.0/1.48
2PH03-070	7.0	200	20	165.0	6/60/10.5/11.7/2.26
2PH03-080	8.0	200	20	195.0	6/60/12.4/13.6/2.26
2PH03-100	10.0	200	20	267.0	6/60/17.2/18.4/2.26
2PH03-120	12.0	200	20	365.0	6/60/23.4/24.6/2.36

A/F POWER HANDLE HEX KEY WRENCH

ITEM NO.	SIZE (A/F)	L1 (mm)	L2 (mm)	⚖️ (g)	PACKING
2PH03-5/64	5/64	100	18	30.0	6/72/2.5/3.5/0.98
2PH03-3/32	3/32	100	18	32.0	6/72/2.8/3.8/0.98
2PH03-7/64	7/64	100	18	34.0	6/72/3.2/4.2/0.98
2PH03-1/8	1/8	100	18	36.0	6/72/3.5/4.5/0.98
2PH03-9/64	9/64	100	18	39.0	6/72/4.3/5.3/0.98
2PH03-5/32	5/32	150	20	70.0	6/72/5.2/6.2/1.48
2PH03-3/16	3/16	150	20	84.0	6/72/6.2/7.2/1.48
2PH03-7/32	7/32	150	20	94.0	6/72/7.4/8.4/1.48
2PH03-1/4	1/4	150	20	109.0	6/72/8.5/9.5/1.48
2PH03-5/16	5/16	200	20	195.0	6/60/12.3/13.5/2.26
2PH03-3/8	3/8	200	20	247.0	6/60/16.8/18.0/2.26
2PH03-1/2	1/2	200	20	400.0	6/60/24.0/25.0/2.36

METRIC POWER HANDLE BALL POINT KEYS

ITEM NO.	SIZE (mm)	L1 (mm)	L2 (mm)	⚖️ (g)	PACKING
2PH33-0127	1.27	100	18	30.0	6/72/2.3/3.3/0.98
2PH33-015	1.5	100	18	30.0	6/72/2.5/3.5/0.98
2PH33-020	2.0	100	18	30.0	6/72/2.5/3.5/0.98
2PH33-025	2.5	100	18	33.0	6/72/3.0/4.0/0.98
2PH33-030	3.0	100	18	36.0	6/72/3.3/4.3/0.98
2PH33-040	4.0	150	20	70.0	6/72/5.3/6.3/1.48
2PH33-050	5.0	150	20	85.0	6/72/6.7/7.7/1.48
2PH33-055	5.5	150	20	94.0	6/72/7.3/8.3/1.48
2PH33-060	6.0	150	20	102.0	6/72/8.0/9.0/1.48
2PH33-070	7.0	200	20	165.0	6/60/10.5/11.7/2.26
2PH33-080	8.0	200	20	195.0	6/60/12.4/13.6/2.26
2PH33-100	10.0	200	20	267.0	6/60/17.2/18.4/2.26
2PH33-120	12.0	200	20	365.0	6/60/23.4/24.6/2.36

POWER HANDLE WRENCH

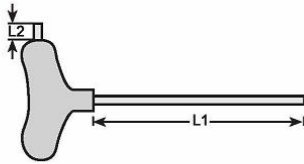

A/F POWER HANDLE BALL POINT KEYS

ITEM NO.	SIZE (inch)	L1 (mm)	L2 (mm)	(g)	PACKING
2PH33-5/64	5/64	100	18	30.0	6/72/2.5/3.5/0.98
2PH33-3/32	3/32	100	18	32.0	6/72/2.8/3.8/0.98
2PH33-7/64	7/64	100	18	34.0	6/72/3.2/4.2/0.98
2PH33-1/8	1/8	100	18	36.0	6/72/3.5/4.5/0.98
2PH33-9/64	9/64	100	18	39.0	6/72/4.3/5.3/0.98
2PH33-5/32	5/32	150	20	70.0	6/72/5.2/6.2/1.48
2PH33-3/16	3/16	150	20	84.0	6/72/6.2/7.2/1.48
2PH33-7/32	7/32	150	20	94.0	6/72/7.4/8.4/1.48
2PH33-1/4	1/4	150	20	109.0	6/72/8.5/9.5/1.48
2PH33-5/16	5/16	200	20	195.0	6/60/12.3/13.5/2.26
2PH33-3/8	3/8	200	20	247.0	6/60/16.8/18.0/2.26
2PH33-1/2	1/2	200	20	400.0	6/60/24.0/25.0/2.36



POWER HANDLE STAR KEY WRENCH

ITEM NO.	SIZE	L1 (mm)	L2 (mm)	(g)	PACKING
2PH13-05	T5	100	18	38.0	6/72/2.3/3.3/0.9
2PH13-06	T6	100	18	38.0	6/72/2.3/3.3/0.9
2PH13-07	T7	100	18	38.0	6/72/2.3/3.3/0.9
2PH13-08	T8	100	18	38.0	6/72/2.3/3.3/0.9
2PH13-09	T9	100	18	39.0	6/72/2.5/3.5/0.98
2PH13-10	T10	100	18	39.0	6/72/2.5/3.5/0.98
2PH13-15	T15	100	18	64.0	6/72/6.2/7.2/1.0
2PH13-20	T20	100	18	64.0	6/72/6.2/7.2/1.0
2PH13-25	T25	150	20	81.0	6/72/7.1/8.1/1.48
2PH13-27	T27	150	20	81.0	6/72/7.1/8.1/1.48
2PH13-30	T30	150	20	96.0	6/72/7.1/8.1/1.48
2PH13-40	T40	200	22	156.0	6/60/9.5/10.5/2.26
2PH13-45	T45	200	22	182.0	6/60/11.1/12.1/2.26
2PH13-50	T50	200	22	214.0	6/60/12.9/13.9/2.26
2PH13-55	T55	200	22	302.0	6/60/18.2/19.2/2.36
2PH13-60	T60	200	22	390.0	6/60/23.4/24.4/2.46



POWER HANDLE TAMPER STAR KEYS

ITEM NO.	SIZE	L1 (mm)	L2 (mm)	(g)	PACKING
H2PH13-05	T5	100	18	38.0	6/72/2.3/3.3/0.9
H2PH13-06	T6	100	18	38.0	6/72/2.3/3.3/0.9
H2PH13-07	T7	100	18	38.0	6/72/2.3/3.3/0.9
H2PH13-08	T8	100	18	38.0	6/72/2.3/3.3/0.9
H2PH13-09	T9	100	18	39.0	6/72/2.5/3.5/0.98
H2PH13-10	T10	100	18	39.0	6/72/2.5/3.5/0.98
H2PH13-15	T15	100	18	64.0	6/72/6.2/7.2/1.0
H2PH13-20	T20	100	18	64.0	6/72/6.2/7.2/1.0
H2PH13-25	T25	150	20	81.0	6/72/7.1/8.1/1.48
H2PH13-27	T27	150	20	81.0	6/72/7.1/8.1/1.48
H2PH13-30	T30	150	20	96.0	6/72/7.1/8.1/1.48
H2PH13-40	T40	200	22	156.0	6/60/9.5/10.5/2.26
H2PH13-45	T45	200	22	182.0	6/60/11.1/12.1/2.26
H2PH13-50	T50	200	22	214.0	6/60/12.9/13.9/2.26
H2PH13-55	T55	200	22	302.0	6/60/18.2/19.2/2.36
H2PH13-60	T60	200	22	390.0	6/60/23.4/24.4/2.46





T TYPE POWER HANDLE WRENCH

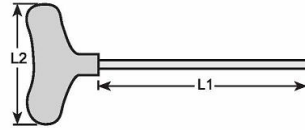

METRIC T TYPE POWER HANDLE HEX KEY WRENCH

ITEM NO.	SIZE (mm)	L1 (mm)	L2 (mm)	⚖️ (g)	PACKING
TH03-0127	1.27	100	70	30.0	6/72/2.3/3.3/0.98
TH03-015	1.5	100	70	30.0	6/72/2.5/3.5/0.98
TH03-020	2.0	100	70	30.0	6/72/2.5/3.5/0.98
TH03-025	2.5	100	70	33.0	6/72/3.0/4.0/0.98
TH03-030	3.0	100	70	36.0	6/72/3.3/4.3/0.98
TH03-040	4.0	150	85	70.0	6/72/5.3/6.3/1.48
TH03-050	5.0	150	85	85.0	6/72/6.7/7.7/1.48
TH03-055	5.5	150	85	94.0	6/72/7.3/8.3/1.48
TH03-060	6.0	150	85	102.0	6/72/8.0/9.0/1.48
TH03-070	7.0	200	100	165.0	6/60/10.5/11.7/2.26
TH03-080	8.0	200	100	195.0	6/60/12.4/13.6/2.26
TH03-100	10.0	200	100	267.0	6/60/17.2/18.4/2.26
TH03-120	12.0	200	100	365.0	6/60/23.4/24.6/2.36



A/F T TYPE POWER HANDLE HEX KEY WRENCH

ITEM NO.	SIZE (inch)	L1 (mm)	L2 (mm)	⚖️ (g)	PACKING
TH03-5/64	5/64	100	70	30.0	6/72/2.5/3.5/0.98
TH03-3/32	3/32	100	70	32.0	6/72/2.8/3.8/0.98
TH03-7/64	7/64	100	70	34.0	6/72/3.2/4.2/0.98
TH03-1/8	1/8	100	70	36.0	6/72/3.5/4.5/0.98
TH03-9/64	9/64	100	70	39.0	6/72/4.3/5.3/0.98
TH03-5/32	5/32	150	85	70.0	6/72/5.2/6.2/1.48
TH03-3/16	3/16	150	85	84.0	6/72/6.2/7.2/1.48
TH03-7/32	7/32	150	85	94.0	6/72/7.4/8.4/1.48
TH03-1/4	1/4	150	85	109.0	6/72/8.5/9.5/1.48
TH03-5/16	5/16	200	100	195.0	6/60/12.3/13.5/2.26
TH03-3/8	3/8	200	100	247.0	6/60/16.8/18.0/2.26
TH03-1/2	1/2	200	100	400.0	6/60/24.0/25.0/2.36



METRIC T TYPE POWER HANDLE BALL POINT KEYS

ITEM NO.	SIZE (mm)	L1 (mm)	L2 (mm)	⚖️ (g)	PACKING
TH33-0127	1.27	100	70	30.0	6/72/2.3/3.3/0.98
TH33-015	1.5	100	70	30.0	6/72/2.5/3.5/0.98
TH33-020	2.0	100	70	30.0	6/72/2.5/3.5/0.98
TH33-025	2.5	100	70	33.0	6/72/3.0/4.0/0.98
TH33-030	3.0	100	70	36.0	6/72/3.3/4.3/0.98
TH33-040	4.0	150	85	70.0	6/72/5.3/6.3/1.48
TH33-050	5.0	150	85	85.0	6/72/6.7/7.7/1.48
TH33-055	5.5	150	85	94.0	6/72/7.3/8.3/1.48
TH33-060	6.0	150	85	102.0	6/72/8.0/9.0/1.48
TH33-070	7.0	200	100	165.0	6/60/10.5/11.7/2.26
TH33-080	8.0	200	100	195.0	6/60/12.4/13.6/2.26
TH33-100	10.0	200	100	267.0	6/60/17.2/18.4/2.26
TH33-120	12.0	200	100	365.0	6/60/23.4/24.6/2.36

T TYPE POWER HANDLE WRENCH

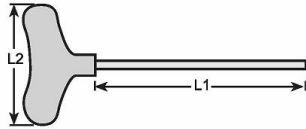

A/F T TYPE POWER HANDLE BALL POINT KEYS

ITEM NO.	SIZE (inch)	L1 (mm)	L2 (mm)	⚖️ (g)	PACKING
TH33-5/64	5/64	100	70	30.0	6/72/2.5/3.5/0.98
TH33-3/32	3/32	100	70	32.0	6/72/2.8/3.8/0.98
TH33-7/64	7/64	100	70	34.0	6/72/3.2/4.2/0.98
TH33-1/8	1/8	100	70	36.0	6/72/3.5/4.5/0.98
TH33-9/64	9/64	100	70	39.0	6/72/4.3/5.3/0.98
TH33-5/32	5/32	150	85	70.0	6/72/5.2/6.2/1.48
TH33-3/16	3/16	150	85	84.0	6/72/6.2/7.2/1.48
TH33-7/32	7/32	150	85	94.0	6/72/7.4/8.4/1.48
TH33-1/4	1/4	150	85	109.0	6/72/8.5/9.5/1.48
TH33-5/16	5/16	200	100	195.0	6/60/12.3/13.5/2.26
TH33-3/8	3/8	200	100	247.0	6/60/16.8/18.0/2.26
TH33-1/2	1/2	200	100	400.0	6/60/24.0/25.0/2.36



T TYPE POWER HANDLE STAR KEY WRENCH

ITEM NO.	SIZE	L1 (mm)	L2 (mm)	⚖️ (g)	PACKING
TH13-05	T5	100	70	38.0	6/72/2.3/3.3/0.9
TH13-06	T6	100	70	38.0	6/72/2.3/3.3/0.9
TH13-07	T7	100	70	38.0	6/72/2.3/3.3/0.9
TH13-08	T8	100	70	38.0	6/72/2.3/3.3/0.9
TH13-09	T9	100	70	39.0	6/72/2.5/3.5/0.98
TH13-10	T10	100	70	39.0	6/72/2.5/3.5/0.98
TH13-15	T15	100	70	64.0	6/72/6.2/7.2/1.0
TH13-20	T20	100	70	64.0	6/72/6.2/7.2/1.0
TH13-25	T25	150	85	81.0	6/72/7.1/8.1/1.48
TH13-27	T27	150	85	81.0	6/72/7.1/8.1/1.48
TH13-30	T30	150	85	96.0	6/72/7.1/8.1/1.48
TH13-40	T40	200	100	156.0	6/60/9.5/10.5/2.26
TH13-45	T45	200	100	182.0	6/60/11.1/12.1/2.26
TH13-50	T50	200	100	214.0	6/60/12.9/13.9/2.26
TH13-55	T55	200	100	302.0	6/60/18.2/19.2/2.36
TH13-60	T60	200	100	390.0	6/60/23.4/24.4/2.46



T TYPE POWER HANDLE TAMPER STAR KEYS

ITEM NO.	SIZE	L1 (mm)	L2 (mm)	⚖️ (g)	PACKING
HTH13-05	T5	100	70	38.0	6/72/2.3/3.3/0.9
HTH13-06	T6	100	70	38.0	6/72/2.3/3.3/0.9
HTH13-07	T7	100	70	38.0	6/72/2.3/3.3/0.9
HTH13-08	T8	100	70	38.0	6/72/2.3/3.3/0.9
HTH13-09	T9	100	70	39.0	6/72/2.5/3.5/0.98
HTH13-10	T10	100	70	39.0	6/72/2.5/3.5/0.98
HTH13-15	T15	100	70	64.0	6/72/6.2/7.2/1.0
HTH13-20	T20	100	70	64.0	6/72/6.2/7.2/1.0
HTH13-25	T25	150	85	81.0	6/72/7.1/8.1/1.48
HTH13-27	T27	150	85	81.0	6/72/7.1/8.1/1.48
HTH13-30	T30	150	85	96.0	6/72/7.1/8.1/1.48
HTH13-40	T40	200	100	156.0	6/60/9.5/10.5/2.26
HTH13-45	T45	200	100	182.0	6/60/11.1/12.1/2.26
HTH13-50	T50	200	100	214.0	6/60/12.9/13.9/2.26
HTH13-55	T55	200	100	302.0	6/60/18.2/19.2/2.36
HTH13-60	T60	200	100	390.0	6/60/23.4/24.4/2.46





T TYPE POWER HANDLE WRENCH

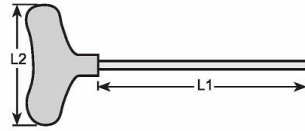

METRIC T TYPE HANDLE HEX KEY WRENCH



ITEM NO.	SIZE (mm)	L1 (mm)	L2 (mm)	⚖️ (g)	PACKING
T03-0127	1.27	100	70	30.0	6/72/2.3/3.3/0.98
T03-015	1.5	100	70	30.0	6/72/2.5/3.5/0.98
T03-020	2.0	100	70	30.0	6/72/2.5/3.5/0.98
T03-025	2.5	100	70	33.0	6/72/3.0/4.0/0.98
T03-030	3.0	100	70	36.0	6/72/3.3/4.3/0.98
T03-040	4.0	150	85	70.0	6/72/5.3/6.3/1.48
T03-050	5.0	150	85	85.0	6/72/6.7/7.7/1.48
T03-055	5.5	150	85	94.0	6/72/7.3/8.3/1.48
T03-060	6.0	150	85	102.0	6/72/8.0/9.0/1.48
T03-070	7.0	200	100	165.0	6/60/10.5/11.7/2.26
T03-080	8.0	200	100	195.0	6/60/12.4/13.6/2.26
T03-100	10.0	200	100	267.0	6/60/17.2/18.4/2.26
T03-120	12.0	200	100	365.0	6/60/23.4/24.6/2.36



A/F T TYPE HANDLE HEX KEY WRENCH



ITEM NO.	SIZE (inch)	L1 (mm)	L2 (mm)	⚖️ (g)	PACKING
T03-5/64	5/64	100	70	30.0	6/72/2.5/3.5/0.98
T03-3/32	3/32	100	70	32.0	6/72/2.8/3.8/0.98
T03-7/64	7/64	100	70	34.0	6/72/3.2/4.2/0.98
T03-1/8	1/8	100	70	36.0	6/72/3.5/4.5/0.98
T03-9/64	9/64	100	70	39.0	6/72/4.3/5.3/0.98
T03-5/32	5/32	150	85	70.0	6/72/5.2/6.2/1.48
T03-3/16	3/16	150	85	84.0	6/72/6.2/7.2/1.48
T03-7/32	7/32	150	85	94.0	6/72/7.4/8.4/1.48
T03-1/4	1/4	150	85	109.0	6/72/8.5/9.5/1.48
T03-5/16	5/16	200	100	195.0	6/60/12.3/13.5/2.26
T03-3/8	3/8	200	100	247.0	6/60/16.8/18.0/2.26
T03-1/2	1/2	200	100	400.0	6/60/24.0/25.0/2.36



METRIC T TYPE HANDLE BALL POINT KEYS



ITEM NO.	SIZE (mm)	L1 (mm)	L2 (mm)	⚖️ (g)	PACKING
T33-0127	1.27	100	70	30.0	6/72/2.3/3.3/0.98
T33-015	1.5	100	70	30.0	6/72/2.5/3.5/0.98
T33-020	2.0	100	70	30.0	6/72/2.5/3.5/0.98
T33-025	2.5	100	70	33.0	6/72/3.0/4.0/0.98
T33-030	3.0	100	70	36.0	6/72/3.3/4.3/0.98
T33-040	4.0	150	85	70.0	6/72/5.3/6.3/1.48
T33-050	5.0	150	85	85.0	6/72/6.7/7.7/1.48
T33-055	5.5	150	85	94.0	6/72/7.3/8.3/1.48
T33-060	6.0	150	85	102.0	6/72/8.0/9.0/1.48
T33-070	7.0	200	100	165.0	6/60/10.5/11.7/2.26
T33-080	8.0	200	100	195.0	6/60/12.4/13.6/2.26
T33-100	10.0	200	100	267.0	6/60/17.2/18.4/2.26
T33-120	12.0	200	100	365.0	6/60/23.4/24.6/2.36

T TYPE POWER HANDLE WRENCH

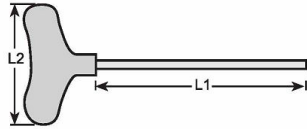

A/F T TYPE HANDLE BALL POINT KEYS

ITEM NO.	SIZE (inch)	L1 (mm)	L2 (mm)	⚖️ (g)	PACKING
T33-5/64	5/64	100	70	30.0	6/72/2.5/3.5/0.98
T33-3/32	3/32	100	70	32.0	6/72/2.8/3.8/0.98
T33-7/64	7/64	100	70	34.0	6/72/3.2/4.2/0.98
T33-1/8	1/8	100	70	36.0	6/72/3.5/4.5/0.98
T33-9/64	9/64	100	70	39.0	6/72/4.3/5.3/0.98
T33-5/32	5/32	150	85	70.0	6/72/5.2/6.2/1.48
T33-3/16	3/16	150	85	84.0	6/72/6.2/7.2/1.48
T33-7/32	7/32	150	85	94.0	6/72/7.4/8.4/1.48
T33-1/4	1/4	150	85	109.0	6/72/8.5/9.5/1.48
T33-5/16	5/16	200	100	195.0	6/60/12.3/13.5/2.26
T33-3/8	3/8	200	100	247.0	6/60/16.8/18.0/2.26
T33-1/2	1/2	200	100	400.0	6/60/24.0/25.0/2.36



T TYPE HANDLE STAR KEY WRENCH

ITEM NO.	SIZE	L1 (mm)	L2 (mm)	⚖️ (g)	PACKING
T13-05	T5	100	70	38.0	6/72/2.3/3.3/0.9
T13-06	T6	100	70	38.0	6/72/2.3/3.3/0.9
T13-07	T7	100	70	38.0	6/72/2.3/3.3/0.9
T13-08	T8	100	70	38.0	6/72/2.3/3.3/0.9
T13-09	T9	100	70	39.0	6/72/2.5/3.5/0.98
T13-10	T10	100	70	39.0	6/72/2.5/3.5/0.98
T13-15	T15	100	70	64.0	6/72/6.2/7.2/1.0
T13-20	T20	100	70	64.0	6/72/6.2/7.2/1.0
T13-25	T25	150	85	81.0	6/72/7.1/8.1/1.48
T13-27	T27	150	85	81.0	6/72/7.1/8.1/1.48
T13-30	T30	150	85	96.0	6/72/7.1/8.1/1.48
T13-40	T40	200	100	156.0	6/60/9.5/10.5/2.26
T13-45	T45	200	100	182.0	6/60/11.1/12.1/2.26
T13-50	T50	200	100	214.0	6/60/12.9/13.9/2.26
T13-55	T55	200	100	302.0	6/60/18.2/19.2/2.36
T13-60	T60	200	100	390.0	6/60/23.4/24.4/2.46



T TYPE HANDLE TAMPER STAR KEYS

ITEM NO.	SIZE	L1 (mm)	L2 (mm)	⚖️ (g)	PACKING
HT13-05	T5	100	70	38.0	6/72/2.3/3.3/0.9
HT13-06	T6	100	70	38.0	6/72/2.3/3.3/0.9
HT13-07	T7	100	70	38.0	6/72/2.3/3.3/0.9
HT13-08	T8	100	70	38.0	6/72/2.3/3.3/0.9
HT13-09	T9	100	70	39.0	6/72/2.5/3.5/0.98
HT13-10	T10	100	70	39.0	6/72/2.5/3.5/0.98
HT13-15	T15	100	70	64.0	6/72/6.2/7.2/1.0
HT13-20	T20	100	70	64.0	6/72/6.2/7.2/1.0
HT13-25	T25	150	85	81.0	6/72/7.1/8.1/1.48
HT13-27	T27	150	85	81.0	6/72/7.1/8.1/1.48
HT13-30	T30	150	85	96.0	6/72/7.1/8.1/1.48
HT13-40	T40	200	100	156.0	6/60/9.5/10.5/2.26
HT13-45	T45	200	100	182.0	6/60/11.1/12.1/2.26
HT13-50	T50	200	100	214.0	6/60/12.9/13.9/2.26
HT13-55	T55	200	100	302.0	6/60/18.2/19.2/2.36
HT13-60	T60	200	100	390.0	6/60/23.4/24.4/2.46





POWER HANDLE WRENCH

Patent

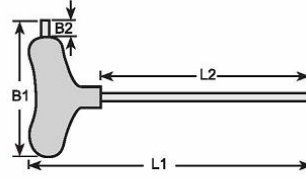

METRIC POWER HANDLE HEX KEY WRENCH

ITEM NO.	SIZE (mm)	L1 (mm)	L2 (mm)	B1 (mm)	B2 (mm)	⚖️ (g)	PACKING
PH03-0127	1.27	135	100	75	12	30.0	6/72/2.3/3.3/0.98
PH03-015	1.5	135	100	75	12	30.0	6/72/2.5/3.5/0.98
PH03-020	2.0	135	100	75	16	30.0	6/72/2.5/3.5/0.98
PH03-025	2.5	135	100	75	16	33.0	6/72/3.0/4.0/0.98
PH03-030	3.0	135	100	75	16	36.0	6/72/3.3/4.3/0.98
PH03-040	4.0	192	150	95	16	70.0	6/72/5.3/6.3/1.48
PH03-050	5.0	192	150	95	17	85.0	6/72/6.7/7.7/1.48
PH03-055	5.5	192	150	95	17	94.0	6/72/7.3/8.3/1.48
PH03-060	6.0	192	150	95	18	102.0	6/72/8.0/9.0/1.48
PH03-070	7.0	240	200	110	21	165.0	6/60/10.5/11.7/2.26
PH03-080	8.0	240	200	110	22	195.0	6/60/12.4/13.6/2.26
PH03-100	10.0	240	200	110	24	267.0	6/60/17.2/18.4/2.26
PH03-120	12.0	240	200	110	24	365.0	6/60/23.4/24.6/2.36

A/F POWER HANDLE HEX KEY WRENCH

ITEM NO.	SIZE (inch)	L1 (mm)	L2 (mm)	B1 (mm)	B2 (mm)	⚖️ (g)	PACKING
PH03-5/64	5/64	135	100	75	16	30.0	6/72/2.5/3.5/0.98
PH03-3/32	3/32	135	100	75	16	32.0	6/72/2.8/3.8/0.98
PH03-7/64	7/64	135	100	75	16	34.0	6/72/3.2/4.2/0.98
PH03-1/8	1/8	135	100	75	16	36.0	6/72/3.5/4.5/0.98
PH03-9/64	9/64	135	100	75	16	39.0	6/72/4.3/5.3/0.98
PH03-5/32	5/32	192	150	95	16	70.0	6/72/5.2/6.2/1.48
PH03-3/16	3/16	192	150	95	17	84.0	6/72/6.2/7.2/1.48
PH03-7/32	7/32	192	150	95	17	94.0	6/72/7.4/8.4/1.48
PH03-1/4	1/4	192	150	95	18	109.0	6/72/8.5/9.5/1.48
PH03-5/16	5/16	240	200	110	22	195.0	6/60/12.3/13.5/2.26
PH03-3/8	3/8	240	200	110	24	247.0	6/60/16.8/18.0/2.26
PH03-1/2	1/2	240	200	110	24	400.0	6/60/24.0/25.0/2.36

METRIC POWER HANDLE BALL POINT KEYS

ITEM NO.	SIZE (mm)	L1 (mm)	L2 (mm)	B1 (mm)	B2 (mm)	⚖️ (g)	PACKING
PH33-0127	1.27	135	100	75	12	30.0	6/72/2.3/3.3/0.98
PH33-015	1.5	135	100	75	12	30.0	6/72/2.5/3.5/0.98
PH33-020	2.0	135	100	75	16	30.0	6/72/2.5/3.5/0.98
PH33-025	2.5	135	100	75	16	33.0	6/72/3.0/4.0/0.98
PH33-030	3.0	135	100	75	16	36.0	6/72/3.3/4.3/0.98
PH33-040	4.0	192	150	95	16	70.0	6/72/5.3/6.3/1.48
PH33-050	5.0	192	150	95	17	85.0	6/72/6.7/7.7/1.48
PH33-055	5.5	192	150	95	17	94.0	6/72/7.3/8.3/1.48
PH33-060	6.0	192	150	95	18	102.0	6/72/8.0/9.0/1.48
PH33-070	7.0	240	200	110	21	165.0	6/60/10.5/11.7/2.26
PH33-080	8.0	240	200	110	22	195.0	6/60/12.4/13.6/2.26
PH33-100	10.0	240	200	110	24	267.0	6/60/17.2/18.4/2.26
PH33-120	12.0	240	200	110	24	365.0	6/60/23.4/24.6/2.36

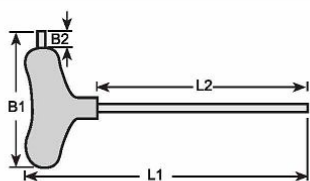

A/F POWER HANDLE BALL POINT KEYS

ITEM NO.	SIZE (inch)	L1 (mm)	L2 (mm)	B1 (mm)	B2 (mm)	(g)	PACKING
PH33-5/64	5/64	135	100	75	16	30.0	6/72/2.5/3.5/0.98
PH33-3/32	3/32	135	100	75	16	32.0	6/72/2.8/3.8/0.98
PH33-7/64	7/64	135	100	75	16	34.0	6/72/3.2/4.2/0.98
PH33-1/8	1/8	135	100	75	16	36.0	6/72/3.5/4.5/0.98
PH33-9/64	9/64	135	100	75	16	39.0	6/72/4.3/5.3/0.98
PH33-5/32	5/32	192	150	95	16	70.0	6/72/5.2/6.2/1.48
PH33-3/16	3/16	192	150	95	17	84.0	6/72/6.2/7.2/1.48
PH33-7/32	7/32	192	150	95	17	94.0	6/72/7.4/8.4/1.48
PH33-1/4	1/4	192	150	95	18	109.0	6/72/8.5/9.5/1.48
PH33-5/16	5/16	240	200	110	22	195.0	6/60/12.3/13.5/2.26
PH33-3/8	3/8	240	200	110	24	247.0	6/60/16.8/18.0/2.26
PH33-1/2	1/2	240	200	110	24	400.0	6/60/24.0/25.0/2.36



POWER HANDLE STAR KEY WRENCH

ITEM NO.	SIZE	L1 (mm)	L2 (mm)	B1 (mm)	B2 (mm)	(g)	PACKING
PH13-05	T5	115	80	75	15	38.0	6/72/2.3/3.3/0.9
PH13-06	T6	115	80	75	15	38.0	6/72/2.3/3.3/0.9
PH13-07	T7	115	80	75	15	38.0	6/72/2.3/3.3/0.9
PH13-08	T8	115	80	75	15	38.0	6/72/2.3/3.3/0.9
PH13-09	T9	135	100	75	16	39.0	6/72/2.5/3.5/0.98
PH13-10	T10	135	100	75	16	39.0	6/72/2.5/3.5/0.98
PH13-15	T15	145	100	90	16	64.0	6/72/6.2/7.2/1.0
PH13-20	T20	145	100	90	16	64.0	6/72/6.2/7.2/1.0
PH13-25	T25	192	150	90	16	81.0	6/72/7.1/8.1/1.48
PH13-27	T27	192	150	90	17	81.0	6/72/7.1/8.1/1.48
PH13-30	T30	192	150	90	17	96.0	6/72/7.1/8.1/1.48
PH13-40	T40	240	200	110	21	156.0	6/60/9.5/10.5/2.26
PH13-45	T45	240	200	110	24	182.0	6/60/11.1/12.1/2.26
PH13-50	T50	240	200	110	24	214.0	6/60/12.9/13.9/2.26
PH13-55	T55	240	200	110	24	302.0	6/60/18.2/19.2/2.36
PH13-60	T60	240	200	110	25	390.0	6/60/23.4/24.4/2.46



POWER HANDLE TAMPER STAR KEYS

ITEM NO.	SIZE	L1 (mm)	L2 (mm)	B1 (mm)	B2 (mm)	(g)	PACKING
HPH13-05	T5	115	80	75	15	38.0	6/72/2.3/3.3/0.9
HPH13-06	T6	115	80	75	15	38.0	6/72/2.3/3.3/0.9
HPH13-07	T7	115	80	75	15	38.0	6/72/2.3/3.3/0.9
HPH13-08	T8	115	80	75	15	38.0	6/72/2.3/3.3/0.9
HPH13-09	T9	135	100	75	16	39.0	6/72/2.5/3.5/0.98
HPH13-10	T10	135	100	75	16	39.0	6/72/2.5/3.5/0.98
HPH13-15	T15	145	100	90	16	64.0	6/72/6.2/7.2/1.0
HPH13-20	T20	145	100	90	16	64.0	6/72/6.2/7.2/1.0
HPH13-25	T25	192	150	90	16	81.0	6/72/7.1/8.1/1.48
HPH13-27	T27	192	150	90	16	81.0	6/72/7.1/8.1/1.48
HPH13-30	T30	192	150	90	16	96.0	6/72/7.1/8.1/1.48
HPH13-40	T40	240	200	110	21	156.0	6/60/9.5/10.5/2.26
HPH13-45	T45	240	200	110	24	182.0	6/60/11.1/12.1/2.26
HPH13-50	T50	240	200	110	24	214.0	6/60/12.9/13.9/2.26
HPH13-55	T55	240	200	110	24	302.0	6/60/18.2/19.2/2.36
HPH13-60	T60	240	200	110	25	390.0	6/60/23.4/24.4/2.46





POWER HANDLE WRENCH SET

Patent



POWER HANDLE HEX KEY & BALL POINT KEY SET (Double Blister)

ITEM NO.	SET	SIZE (mm)	PACKING
PH03-D7SN	7pcs	HEX KEY: 3, 4, 5, 6, 7, 8, 10	18/18.0/1.85
PH03-DL7SN	7pcs	HEX KEY: 3, 4, 5, 6, 8, 10, 12	12/13.2/14.2/1.22
PH33-D7SN	7pcs	BALL POINT HEX KEY: 3, 4, 5, 6, 7, 8, 10	18/18.0/1.85
PH33-DL7SN	7pcs	BALL POINT HEX KEY: 3, 4, 5, 6, 8, 10, 12	12/13.2/14.2/1.22



POWER HANDLE STAR KEY & TAMPER STAR KEY (Double Blister)

ITEM NO.	SET	SIZE	PACKING
PH13-D7SN	7pcs	STAR KEY: T15, T20, T25, T27, T30, T40, T45	12/9.6/1.22
HPH13-D7SN	7pcs	TAMPER STAR KEY: T15, T20, T25, T27, T30, T40, T45	12/9.6/1.22



POWER HANDLE BALL ON BALL POINT KEY SET (Double Blister)

ITEM NO.	SET	SIZE (mm)(inch)	PACKING
PHB33-D7SN	7pcs	3, 4, 5, 6, 7, 8, 10	18/18.0/1.85
PHB33-D7SHN	7pcs	1/8, 5/32, 3/16, 1/4, 9/32, 5/16, 3/8	18/18.0/1.85



POWER HANDLE HEX KEY & BALL POINT KEY SET (Double Blister)

ITEM NO.	SET	SIZE (mm)(inch)	PACKING
PH03-D6SN	6pcs	HEX KEY: 2, 2.5, 3, 4, 5, 6	20/40/14.4/15.4/2.9
PH03-D6SHN	6pcs	HEX KEY: 5/64, 3/32, 1/8, 5/32, 3/16, 1/4	20/40/14.4/15.4/2.9
PH33-D6SN	6pcs	BALL POINT: 2, 2.5, 3, 4, 5, 6	20/40/14.4/15.4/2.9
PH33-D6SHN	6pcs	BALL POINT: 5/64, 3/32, 1/8, 5/32, 3/16, 1/4	20/40/14.4/15.4/2.9



POWER HANDLE STAR KEY & TAMPER STAR KEY SET (Double Blister)

ITEM NO.	SET	SIZE	PACKING
PH13-D6SN	6pcs	STAR KEY: T8, T9, T10, T15, T20, T25	20/40/12.8/13.8/2.9
HPH13-D6SN	6pcs	TAMPER STAR: T8, T9, T10, T15, T20, T25	20/40/12.8/13.8/2.9



POWER HANDLE HEX KEY SET

(Steel Rack + Color Box)

ITEM NO.	SET	SIZE (mm)(inch)	PACKING
PH03-Z6SN	6pcs	2, 2.5, 3, 4, 5, 6	20/12.7/1.5
PH03-Z8SN	8pcs	2, 2.5, 3, 4, 5, 6, 8, 10	12/14.4/1.5
PH03-Z9SN	9pcs	2, 2.5, 3, 4, 5, 5.5, 6, 8, 10	12/15.4/1.5
PH03-Z0SN	10pcs	2, 2.5, 3, 4, 5, 5.5, 6, 8, 10, 12	12/19.5/1.5
PH03-Z6SHN	6pcs	5/64, 3/32, 1/8, 5/32, 3/16, 1/4	20/13.2/1.5
PH03-Z8SHN	8pcs	5/64, 3/32, 1/8, 5/32, 3/16, 1/4, 5/16, 3/8	12/14.4/1.5
PH03-Z0SHN	10pcs	5/64, 3/32, 1/8, 5/32, 3/16, 7/32, 1/4, 5/16, 3/8, 1/2	12/19.3/1.5



POWER HANDLE BALL POINT HEX KEY

(Steel Rack + Color Box)

ITEM NO.	SET	SIZE (mm)(inch)	PACKING
PH33-Z6SN	6pcs	2, 2.5, 3, 4, 5, 6	20/12.7/1.5
PH33-Z8SN	8pcs	2, 2.5, 3, 4, 5, 6, 8, 10	12/14.4/1.5
PH33-Z9SN	9pcs	2, 2.5, 3, 4, 5, 5.5, 6, 8, 10	12/15.4/1.5
PH33-Z0SN	10pcs	2, 2.5, 3, 4, 5, 5.5, 6, 8, 10, 12	12/19.5/1.5
PH33-Z6SHN	6pcs	5/64, 3/32, 1/8, 5/32, 3/16, 1/4	20/13.2/1.5
PH33-Z8SHN	8pcs	5/64, 3/32, 1/8, 5/32, 3/16, 1/4, 5/16, 3/8	12/14.4/1.5
PH33-Z0SHN	10pcs	5/64, 3/32, 1/8, 5/32, 3/16, 7/32, 1/4, 5/16, 3/8, 1/2	12/19.3/1.5



POWER HANDLE STAR KEY SET

(Steel Rack + Color Box)

ITEM NO.	SET	SIZE	PACKING
PH13-Z6SN	6pcs	T10, T15, T20, T25, T30, T40	20/13.6/1.5
PH13-Z8SN	8pcs	T9, T10, T15, T20, T25, T27, T30, T40	12/17.6/1.5
PH13-Z9SN	9pcs	T10, T15, T20, T25, T27, T30, T40, T45, T50	12/16.0/1.5
PH13-Z0SN	10pcs	T10, T15, T20, T25, T27, T30, T40, T45, T50, T55	12/19.4/1.5



POWER HANDLE TAMPER STAR KEY SET

(Steel Rack + Color Box)

ITEM NO.	SET	SIZE	PACKING
HPH13-Z6SN	6pcs	T10, T15, T20, T25, T30, T40	20/13.6/1.5
HPH13-Z8SN	8pcs	T9, T10, T15, T20, T25, T27, T30, T40	12/17.6/1.5
HPH13-Z9SN	9pcs	T10, T15, T20, T25, T27, T30, T40, T45, T50	12/16.0/1.5
HPH13-Z0SN	10pcs	T10, T15, T20, T25, T27, T30, T40, T45, T50, T55	12/19.4/1.5





POWER HANDLE WRENCH SET

Patent



POWER HANDLE HEX KEY WRENCH SET (Blow Case)

ITEM NO.	SET	SIZE (mm)(inch)	PACKING
PH03-7SN	7pcs	2.5, 3, 4, 5, 6, 8, 10	12/16.3/17.3/2.1
PH03-7SHN	7pcs	3/32, 1/8, 5/32, 3/16, 1/4, 5/16, 3/8	12/16.3/17.3/2.1
PH03-9SN	9pcs	2, 2.5, 3, 4, 5, 6, 8, 10, 12	12/21.0/22.0/3.0
PH03-9SHN	9pcs	5/64, 3/32, 1/8, 5/32, 3/16, 1/4, 5/16, 3/8, 1/2	12/21.0/22.0/3.0



POWER HANDLE BALL POINT HEX KEY SET (Blow Case)

ITEM NO.	SET	SIZE (mm)(inch)	PACKING
PH33-7SN	7pcs	2.5, 3, 4, 5, 6, 8, 10	12/16.3/17.3/2.1
PH33-7SHN	7pcs	3/32, 1/8, 5/32, 3/16, 1/4, 5/16, 3/8	12/16.3/17.3/2.1
PH33-9SN	9pcs	2, 2.5, 3, 4, 5, 6, 8, 10, 12	12/21.0/22.0/3.0
PH33-9SHN	9pcs	5/64, 3/32, 1/8, 5/32, 3/16, 1/4, 5/16, 3/8, 1/2	12/21.0/22.0/3.0



POWER HANDLE STAR KEY & TAMPER STAR KEY SET (Blow Case)

ITEM NO.	SET	SIZE	PACKING
PH13-9SN	9pcs	STAR KEY: T10, T15, T20, T25, T27, T30, T40, T45, T50	12/21.0/22.0/3.0
HPH13-9SN	9pcs	TAMPER STAR: T10, T15, T20, T25, T27, T30, T40, T45, T50	12/21.0/22.0/3.0



POWER HANDLE BALL ON BALL POINT HEX KEY SET (Blow Case)

ITEM NO.	SET	SIZE (mm)(inch)	PACKING
BPH33-7SN	7pcs	2.5, 3, 4, 5, 6, 8, 10	12/16.3/17.3/2.1
BPH33-7SHN	7pcs	3/32, 1/8, 5/32, 3/16, 1/4, 5/16, 3/8	12/16.3/17.3/2.1
BPH33-9SN	9pcs	2, 2.5, 3, 4, 5, 6, 8, 10, 12	12/21.0/22.0/3.0
BPH33-9SHN	9pcs	5/64, 3/32, 1/8, 5/32, 3/16, 1/4, 5/16, 3/8, 1/2	12/21.0/22.0/3.0



POWER HANDLE HEX KEY (Color Box)

ITEM NO.	SET	SIZE (mm)(inch)	PACKING
PH03-C8SN	8pcs	2, 2.5, 3, 4, 5, 6, 8, 10	12/12.9/1.5
PH03-C8SHN	8pcs	3/32, 1/8, 5/32, 3/16, 7/32, 1/4, 5/16, 3/8	12/14.5/1.5



POWER HANDLE BALL POINT HEX KEY (Color Box)

ITEM NO.	SET	SIZE (mm)(inch)	PACKING
PH33-C8SN	8pcs	2, 2.5, 3, 4, 5, 6, 8, 10	12/12.9/1.5
PH33-C8SHN	8pcs	3/32, 1/8, 5/32, 3/16, 7/32, 1/4, 5/16, 3/8	12/14.5/1.6



POWER HANDLE BALL ON BALL POINT HEX KEY (Color Box)

ITEM NO.	SET	SIZE (mm)(inch)	PACKING
PHB33-C8SN	8pcs	3, 4, 5, 5.5, 6, 7, 8, 10	12/13.0/14.0/1.5
PHB33-C8SHN	8pcs	1/8, 9/64, 5/32, 3/16, 7/32, 1/4, 5/16, 3/8	12/11.9/12.9/1.5



POWER HANDLE STAR KEY & TAMPER STAR KEY SET (Color Box)

ITEM NO.	SET	SIZE	PACKING
PH13-C7SN	7pcs	STAR KEY: T10, T15, T20, T25, T27, T30, T40	12/10.2/1.33
HPH13-C7SN	7pcs	TAMPER STAR: T10, T15, T20, T25, T27, T30, T40	12/10.2/1.33



POWER HANDLE WRENCH SET

Patent

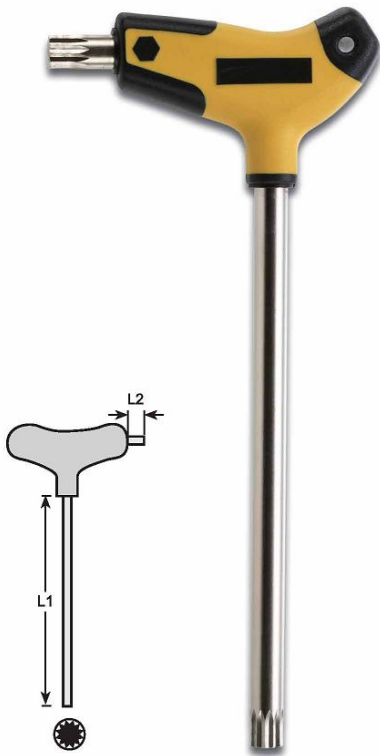

POWER HANDLE SPLINE KEY WRENCH

ITEM NO.	SIZE	L1 (mm)	L2 (mm)	⚖️ (g)
PH23-030	M3	100	15	24.0
PH23-040	M4	100	16	50.0
PH23-050	M5	150	16	66.0
PH23-060	M6	150	17	82.0
PH23-080	M8	190	21	170.0
PH23-090	M9	190	21	200.0
PH23-100	M10	190	22	235.0
PH23-120	M12	190	22	290.0



POWER HANDLE SPLINE KEY SET (Double Blister)

ITEM NO.	SET	SIZE	PACKING
PH23-D7SN	7pcs	M3, M4, M5, M6, M8, M10, M12	12/14.0/1.22
PH23-DS7SN	7pcs	M3, M4, M5, M6, M8, M9, M10	12/12.5/1.22

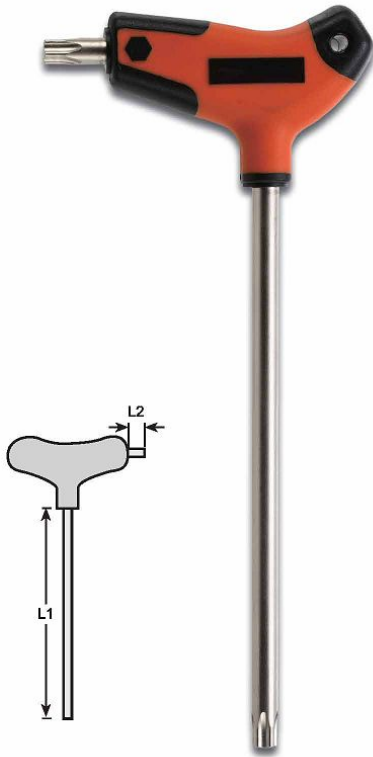

POWER HANDLE

5-LOBE STAR KEY WRENCH

ITEM NO.	SIZE	L1 (mm)	L2 (mm)	⚖️ (g)
PH53-08	TS8	80	15	38.0
PH53-09	TS9	100	16	39.0
PH53-10	TS10	100	16	39.0
PH53-15	TS15	100	16	64.0
PH53-20	TS20	100	16	64.0
PH53-25	TS25	150	16	81.0
PH53-27	TS27	150	16	81.0
PH53-30	TS30	150	16	96.0
PH53-40	TS40	190	21	156.0
PH53-45	TS45	190	24	182.0
PH53-50	TS50	190	24	214.0



POWER HANDLE

5-LOBE TAMPER STAR KEY WRENCH

ITEM NO.	SIZE	L1 (mm)	L2 (mm)	⚖️ (g)
HPH53-08	TS8	80	15	38.0
HPH53-09	TS9	100	16	39.0
HPH53-10	TS10	100	16	39.0
HPH53-15	TS15	100	16	64.0
HPH53-20	TS20	100	16	64.0
HPH53-25	TS25	150	16	81.0
HPH53-27	TS27	150	16	81.0
HPH53-30	TS30	150	16	96.0
HPH53-40	TS40	190	21	156.0
HPH53-45	TS45	190	24	182.0
HPH53-50	TS50	190	24	214.0



POWER HANDLE 5-LOBE STAR KEY SET (Double Blister)

ITEM NO.	SET	SIZE	PACKING
PH53-D7SN	7pcs	TORX: TS15, TS20, TS25, TS27, TS30, TS40, TS45	12/9.6/1.22
HPH53-D7SN	7pcs	TAMPER : TS15, TS20, TS25, TS27, TS30, TS40, TS45	12/9.6/1.22



KEY DRIVER

Patent



STAR KEY FLAGDRIVER

ITEM NO.	SIZE	L (mm)	⚖️ (g)
PF11-05	T5	37	5.0
PF11-06	T6	37	5.0
PF11-07	T7	37	5.0
PF11-08	T8	37	5.0
PF11-09	T9	37	5.0
PF11-10	T10	37	5.0
PF11-15	T15	46	11.0
PF11-20	T20	46	11.0



STAR KEY WINGDRIVER

ITEM NO.	SIZE	L (mm)	⚖️ (g)
PF12-05	T5	37	11.0
PF12-06	T6	37	11.0
PF12-07	T7	37	11.0
PF12-08	T8	37	11.0
PF12-09	T9	37	11.0
PF12-10	T10	37	11.0
PF12-15	T15	46	16.0
PF12-20	T20	46	16.0
PF12-25	T25	50	30.0
PF12-27	T27	50	30.0
PF12-30	T30	50	30.0



HEX KEY WINGDRIVER

ITEM NO.	SIZE (mm)	L (mm)	⚖️ (g)
PF02-0127	1.27	37	11.0
PF02-0150	1.5	37	11.0
PF02-0200	2.0	37	11.0
PF02-0250	2.5	37	11.0
PF02-0300	3.0	37	11.0
PF02-0350	3.5	46	23.0
PF02-0400	4.0	46	23.0
PF02-0450	4.5	46	25.0
PF02-0500	5.0	46	25.0

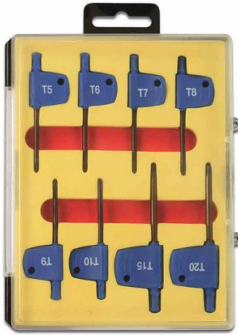

STAR KEY COMBINATION FLAG DRIVER (Plastic Case)

ITEM NO.	SET	SIZE	PACKING
PF11-P8SR	8pcs	T5, T6, T7, T8, T9, T10, T15, T20	72/14.5/15.5/2.25

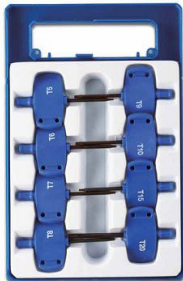

STAR KEY COMBINATION WING DRIVER (Plastic Case)

ITEM NO.	SET	SIZE	PACKING
PF12-P8SR	8pcs	T5, T6, T7, T8, T9, T10, T15, T20	48/16.4/17.4/2.3
PF12-PL8SR	8pcs	T8, T9, T10, T15, T20, T25, T27, T30	48/18.0/19.0/2.3



STAR KEY REPLACEABLE WING DRIVER (Plastic Case)

ITEM NO.	SET	SIZE	PACKING
PF13-P9SN	9pcs	T5, T6, T7, T8, T9, T10, T15, T20, T25	72/12.6/13.6/1.6



HEX KEY REPLACEABLE WING DRIVER (Plastic Case)

ITEM NO.	SET	SIZE	PACKING
PF03-P9MSN	9pcs	1.27, 1.5, 2, 2.5, 3, 3.5, 4, $\ominus \oplus$	72/12.6/13.6/1.6
PF03-P9HSN	9pcs	0.05, 1/16, 5/64, 3/32, 7/64, 1/8, 9/64, 5/32, \oplus	72/12.6/13.6/1.6



HEX & STAR KEY REPLACEABLE WING DRIVER (Plastic Case)

ITEM NO.	SET	SIZE	PACKING
PF13-P17MSN	17pcs	HEX: 1.5, 2, 2.5, 3, 3.5, 4 SCREW: $\ominus \oplus$ STAR: T5, T6, T7, T8, T9, T10, T15, T20, T25	72/15.2/16.2/1.6
PF13-P17HSN	17pcs	HEX: 0.05, 1/16, 5/64, 3/32, 7/64, 1/8, 9/64, 5/32 STAR: T5, T6, T7, T8, T9, T10, T15, T20, T25	72/15.2/16.2/1.6